



Our Vision is Your Vision

2026 Marine Catalog

SEATRONX: (800) 607-1460 • info@seatronx.com • www.seatronx.com
MAILING & ACCOUNT PAYABLE: PO BOX 1713, HOBE SOUND, FL 33475
WAREHOUSE & PRODUCTION: 2470 N. DECATUR BLVD. SUITE 165, LAS VEGAS, NV 89108

CONTENTS

PANEL MOUNT	VSRT Series	Sunlight Readable Marine Touchscreen Displays	Page 3
	CD Series	LCD Commercial Displays	Page 7
PANEL MOUNT WITH VESA MOUNT	SRT/PHT Series	LCD Marine/Industrial Displays (SRT-Sunlight Readable; PHT-Pilot House).....	Page 9
GLASS POD DISPLAYS		Customized Glass Pods and Curved Acrylic	Page 13
PANEL MOUNT WITH VESA MOUNT	IND Series	LED Sunlight Readable Industrial Displays	Page 16
	SXT Extreme Series	100% Sealed IP67 Waterproof Sunlight Readable Display	Page 18
	RRD & LCRD	River Radar Display (RRD) & Low Cost River Display (LCRD).....	Page 20
RACK DRAWER MOUNT	MDRM-19	19" 1280x1024 LCD Multi-Display Rack Mount, Dual or Triple Display Options!	Page 23
	IND-XX-RDKB-20	20" Depth, Rack Drawer with Rugged Clamshell Design	Page 23
	IND-XX-RD1U-24	24" Depth, Rack Drawer with Rugged Clamshell Design	Page 23
	IND-XX-RD1U-20	20" Depth, 1U KVM Rack Drawer with the Keyboard and Monitor Moving	Page 23
	IND-XX-RDKB-KVM-20	20" Depth, KVM Rack-Drawer with Keyboard and Monitor	Page 23
	IND-XX-RDKBMP-24	24" Depth, KVM Rack-Drawer with Keyboard and Monitor	Page 23
	RD-KB-XX	17" Depth, Rack-Drawer for Keyboard Only	Page 23
	RD-KB-KVM-XX	KVM Rack-Drawer for Keyboard Only	Page 23
	FD-MP-XX	Fold-Down Multi-position; 1U LCD Display Drawer with 17" LCD Monitor	Page 24
	FD-MP-20	1 U Military Drawer Mount, Multi-position Fold-Down, 19" Rack	Page 24
PORTABLE	RVT-7	Sunlight Readable Rugged Tablet	Page 24
	Hydros-7	Waterproof 7" Marine Tablet	Page 24
DIGITAL CONTROLS	SCC	SCC - Seatronx Command Control	Page 27
	PHT-SRT-CTL	Remote Control Unit for PHT/SRT Monitors	Page 29
COMPUTERS	MPPC Series	LCD Marine Panel PCs	Page 30
	MPC/SEA Series	Seatronx Marine PCs	Page 32
	Andros 8	Rugged Android Computer	Page 34
TRACKBALLS & KEYBOARDS		Waterproof Trackballs and Waterproof Keyboards	Page 35
		Custom Keyboards & Control Panels	Page 40
SURFVISION HD	Camera and Recording System	Page 41
MARINE & INDUSTRIAL CCTV SYSTEMS	DNV & CCS, IECEX & ATEX, High-Temp. Resistant CCTV Cameras	Page 42

Seatronx LLC ("Seatronx") is committed to maintaining the integrity of its brand and the long-term value of its premium marine electronics products. Seatronx LLC sells marine electronics exclusively through a network of authorized dealers and distributors, and to preserve the value and competitive position of our resellers, we require Minimum Advertised Pricing (MAP).
 Minimum Advertised Price (MAP) Requirement: Advertised products may be listed no lower than 15% below MSRP Pricing.
 This MAP Policy applies to all authorized Seatronx dealers and distributors including any person or company who advertises Seatronx for resale purpose, and sells Seatronx products through any public channel, including but not limited to websites, online marketplaces, social media platforms, print advertising, email campaigns, and any other publicly accessible media. "Advertising" includes any price listing accessible by the public prior to entering a purchase transaction, including but not limited to: Website listings (including search results, landing pages, checkout pages if pricing is visible), Online ads or banners, Marketplace listings, Email marketing with pricing, Print materials and Social media posts with pricing.
 Failure to adhere to this MAP Policy will result in unilateral action by Seatronx, which may include the following consequences, without prior notice: Issuance of a formal warning, Suspension of product shipments, Removal from the list of authorized dealers/distributors, Termination of dealership or distribution agreement
 Seatronx reserves the right to determine, in its sole discretion, whether a violation has occurred and what enforcement action is appropriate.
 All resellers remain free to set their own actual resale prices. This MAP Policy applies only to advertised prices, not the actual sale price. Nothing herein shall be construed to interfere with the independent pricing decisions of any dealer or distributor.
 Seatronx's MAP Policy is implemented in compliance with applicable U.S. antitrust and competition laws.
 Seatronx reserves the right to modify, update, or discontinue this MAP Policy at any time.



VSRT Series

The Undisputed Champion of Sunlight Readable Marine Displays

The V Series Sunlight Readable Touchscreen (VSRT) Displays are designed for the Marine industry. These rugged displays deliver crisp text, fast response and optimized viewing angles under any outdoor lighting conditions due to our bonding technology. The VSRT series is ideal for high sunlight areas such as cockpits, decks and bright pilothouses. The sleek design allows maximum screen size in the smallest spaces available. Available Screen Sizes: 15", 17", 19", 21" (wide), 24" (wide)

- *Amazing 8 Inputs*
- *Night Mode with Backlight (optional colors)*
- *Red Mode*
- *Unmatched Clarity*
- *Exceptional Viewing Angles*
- *Compatible with SCC Control Command System*

Standard Displays

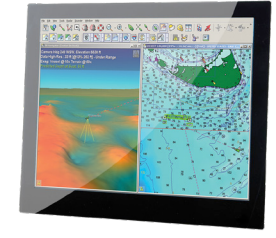
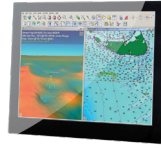

Seatronx Part Numbers	VSRT-15	VSRT-17	VSRT-19	VSRT-213
FEATURES				
Diagonal (active area) Inch	15.0	17.0	19.0	21.3
Native Resolution (Pixels)	1024x 768	1280x1024	1280x 1024	1600x1200
Colors	16.2M	16.7M	16.7M	16.7M
IPS Technology	YES	YES	YES	YES
Contrast Ratio	2000:1	1000:1	1500:1	1200:1
Sunlight Readable	1000+	1000+	1000+	1000+
Viewing Angle (left, right)	89,89	89,89	89, 89	89, 89
Viewing Angle (up, down)	89,89	89,89	89, 89	89, 89
Backlight Lifetime (Hrs)	50000+	50000+	50000+	50000+
Backlight Dimming	0 - max	0 - max	0 - max	0 - max
Inputs	2xDVID, 1xVGA, 1xDP,4xComp	2xDVID, 1xVGA, 1xDP,4xComp	2xDVID, 1xVGA, 1xDP,4xComp	2xDVID, 1xVGA, 1xDP,4xComp
Power Source	9-36V + and -	9-36V + and -	9-36V + and -	9-36V + and -
Voltage converter	9-36V (isolated)	9-36V (isolated)	9-36V (isolated)	9-36V (isolated)
Power consumption AMPS at 24vdc	2.8	3	3.5	3.5
Inlet plug dc power	Screw Terminal	Screw Terminal	Screw Terminal	Screw Terminal
Dimensions front (w x h x d) mm (inches)	365.02 x 287.21 x 76.20mm (14.371 x 11.328 x 3)	399.78 x 331.91 x 76.20mm (15.70 x 13.039 x 3)	437.35 x 362.10 x 76.20mm (17.219 x 14.256 x 3)	390.00 x 498.04 x 76 19.608 x 15.354 x 3
Cutout Dimensions (w x h x d) mm (inches)	350.37 x 274.61 x 76mm (13.794 x 10.81 x 2.992)	384.24 x 318.69 x 76.20mm (15.127x 12.547 x 3)	430.04 x 356.22 x 76.20mm (16.931 x 14.024 x 3)	468.88 x 360.671 (18.460 x 360.681)
Sealing front	IP65	IP65	IP65	IP65
Mounting	Panel Mount	Panel Mount	Panel Mount	Panel Mount
Operating temperature (°C)	-20 to +70	-10 to 70	-10 to 70	-10 to 70
Storage temperature (°C)	-30 to 80	-20 to 80	-20 to 80	-20 to 80
Parameter adjustment	Remote Keypad	Remote Keypad	Remote Keypad	Remote Keypad
Power on/off	Remote Keypad	Remote Keypad	Remote Keypad	Remote Keypad
Projected Capacitive touch	YES	YES	YES	YES
Optical bonding	YES	YES	YES	YES
Remote control VIA RS232 or IP	YES	YES	YES	YES

Wide Screen Displays

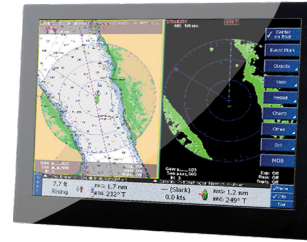

Seatronx Part Numbers	VSRT-19W	VSRT-21W	VSRT-24W
FEATURES			
Diagonal (active area) Inch	18.5	21.5	24.0
Native Resolution (Pixels)	1920x1080	1920x1080	1920x1080
Colors	16.7M	16.7M	16.7M
IPS Technology	YES	YES	YES
Contrast Ratio	5000:1	5000:1	5000:1
Sunlight Readable	1000+	1000+	1000+
Viewing Angle (left, right)	89,89	89, 89	89, 89
Viewing Angle (up, down)	89,89	89, 89	89, 89
Backlight Lifetime (Hrs)	50000+	50000+	50000+
Backlight Dimming	0 - max	0 - max	0 - max
Inputs	2xDVID,1xVGA,1xDP,4xComp	2xDVID, 1xVGA, 1xDP,4xComp	2xDVID, 1xVGA, 1xDP,4xComp
Power Source	9-36V + and -	9-36V + and -	9-36V + and -
Voltage converter	9-36V (isolated)	9-36V (isolated)	9-36V (isolated)
Power consumption AMPS at 24vdc	3.5	3.5	3.5
Inlet plug dc power	Screw Terminal	Screw Terminal	Screw Terminal
Dimensions front (w x h x d) mm (inches)	463.79 x 284.87 x76.20mm (18.259 x 11.215 x 3)	532.92 x 328.92 x 76.20mm (20.981 x 12.950 x 3)	584.82 x 352.35 x 76.20mm (23.024 x 13.872 x 3)
Cutout Dimensions (w x h x d) mm (inches)	447.74 x 268.31 x 76.20mm (17.627x 10.563 x 3)	518.39 x 315.03 x 76.20mm (20.409 x 12.403 x 3)	570.04 x 338.46 x 76.20mm (22.442 x 13.325 x 3)
Sealing front	IP66	IP65	IP65
Mounting	Panel Mount	Panel Mount	Panel Mount
Operating temperature (°C)	-10 to 70	0 to +60	0 to +60
Storage temperature (°C)	-20 to 80	-20 to 70	-20 to 70
Parameter adjustment	Remote Keypad	Remote Keypad	Remote Keypad
Power on/off	Remote Keypad	Remote Keypad	Remote Keypad
Projected Capacitive touch	YES	YES	YES
Optical bonding	YES	YES	YES
Remote control VIA RS232 or IP	YES	YES	YES

Seatronx V Series Sunlight Readable Marine Displays

Part Number:	Description :
VSRT-15	15" IPS 1024x768 Sunlight readable touch screen display, 9-36vdc, 2 DVID, 1 DP, 1 VGA, 4 Composite, PIP, HDCPCompliant, wide dimming range and RS232/Ethernet Communications
VSRT-17	17" IPS 1280x1024 Sunlight readable touch screen display, 9-36vdc, 2 DVID, 1 DP, 1 VGA, 4 Composite, PIP, HDCPCompliant ,wide dimming range and RS232/Ethernet Communications
VSRT-19	19" IPS 1280x1024 Sunlight readable touch screen display, 9-36vdc, 2 DVID, 1 DP, , 1 VGA, 4 Composite, PIP, HDCPCompliant, wide dimming range and RS232/Ethernet Communications
VSRT-19W	18.5" IPS 1920x1080 Sunlight readable touch screen display, 9-36vdc, 2 DVID, 1 DP, , 1 VGA, 4 Composite, PIP, HDCPCompliant, wide dimming range and RS232/Ethernet Communications
VSRT-213	21.3" IPS 1600x1200 Sunlight readable touch screen, 5:4 square format display. 9-36vdc, 2 DVID, 1 DP, , 1 VGA, 4 Composite, PIP, HDCP Compliant, wide dimming range and RS232/Ethernet Communications, (Replacement for Aydin and Seatronx KMGB21 series)
VSRT-21W	21.5" IPS 1920x1080 Sunlight readable touch screen display, 9-36vdc, 2 DVID, 1 DP, , 1 VGA, 4 Composite, PIP, HDCPCompliant, wide dimming range and RS232/Ethernet Communications
VSRT-24W	24" IPS 1920x1080 Sunlight readable touch screen display, 9-36vdc, 2 DVID, 1 DP, 1 VGA, 4 Composite, PIP, HDCP Compliant, wide dimming range and RS232/Ethernet Communications
SRT/PHT-AC-PWR-24	110 vdc AC Power adapter , rating 24 vdc 5A 60w bare wire

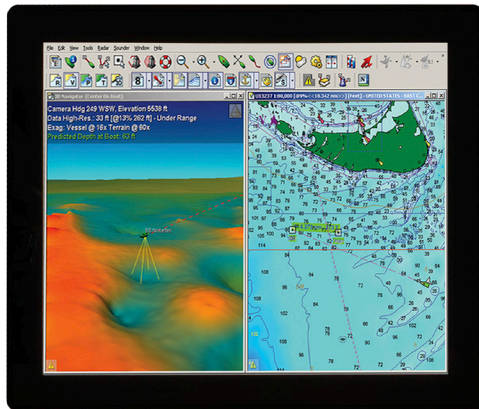

FRONT VIEW



REAR VIEW



KEYPAD INCLUDED

Optional Digital Controls Available - SCC Series. See details on the following pages.

CD Series

LCD Commercial Displays

CD Series

Displays Designed for Commercial Industries.

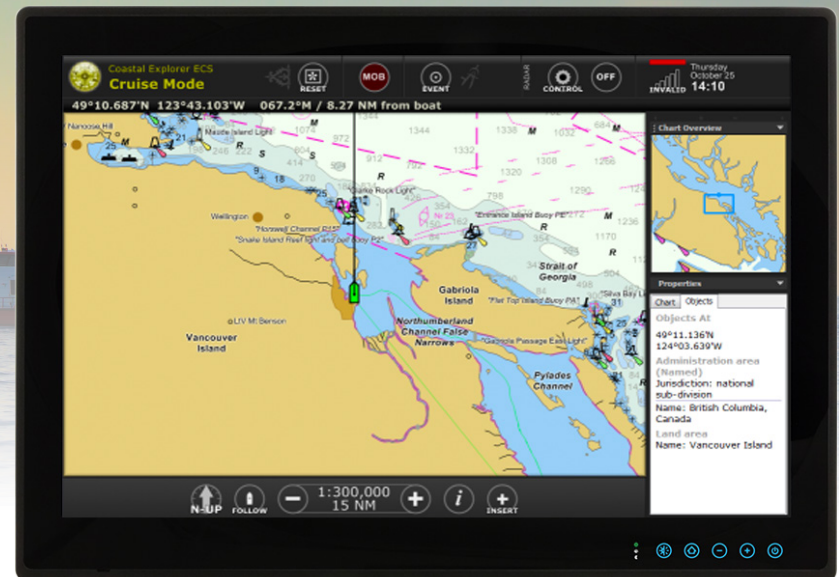
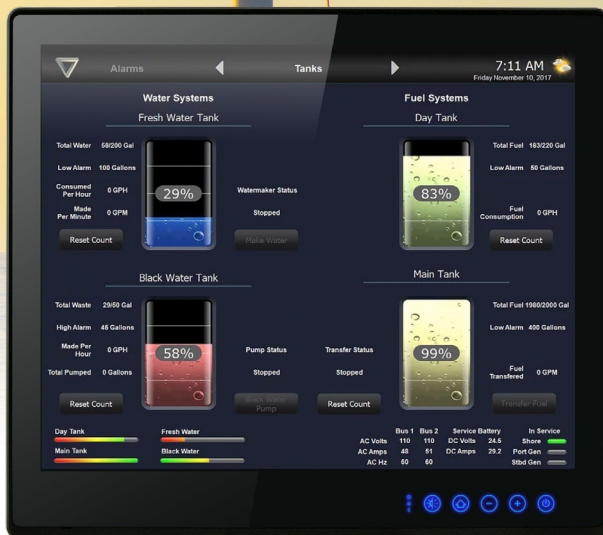

- 15" (1024x768), 19" (1280x1040), 24" (1920x1080) and 26" (1920x1200) Commercial Displays With Projective Capacitive Multi-Touch Screen
- Color Calibrated For ECDIS Compliance (Optional)
- Capacitive Touch Keys For Quick Function Access and Display Control (Support ECDIS Day, Dusk, and Night Mode Switching)
- Meets The Requirements Of Industrial Marine Standards, Including IEC60945 4th Edition, DNVGL-CG-0339, IACS E10

Seatronx Commercial Displays



SPECIFICATIONS:

Marine ECDIS Displays	CD-15T	CD-19T	CD-24T	CD-26T
Diagonal (active area) Inch	15	19	24	26
Native Resolution (Pixels)	1024 x 768	1280 x 1024	1920 x 1080	1920 x 1200
Colors	16.7M	16.7M	16.7M	16.7M
Contrast Ratio	2500:1	1200:1	5000:1	1500:1
Brightness	500	350	350	350
Viewing Angle (left, right)	88, 88	89, 89	89, 89	89, 89
Viewing Angle (up, down)	88, 88	89, 89	89, 89	89, 89
Backlight Dimming	-0 (3 Stage ECDIS Option)	-0 (3 Stage ECDIS Option)	-0 (3 Stage ECDIS Option)	-0 (3 Stage ECDIS Option)
Inputs	1 each: VGA, DVID, HDMI1.4	1 each: VGA, DVID, HDMI1.4	1 each: VGA, DVID, HDMI1.4	1 each: VGA, DVID, HDMI1.4
Remote Control	RS232	RS232	RS232	RS232
USB For Touch Screen	YES	YES	YES	YES
Speaker	2x 2W Speaker	2x 2W Speaker	2x 2W Speaker	2x 2W Speaker
Buzzer	75 dB~80 dB, 230 Hz, 1m	75 dB~80 dB, 230 Hz, 1m	76 dB~80 dB, 230 Hz, 1m	77 dB~80 dB, 230 Hz, 1m
Power	9-36VDC Isolated power supply 35W (Typ.)	9-36VDC Isolated power supply 60W (Max)	9-36VDC Isolated power supply 70W (Max)	9-36VDC Isolated power supply 80W (Max)
Power on/off dimming control	Front Bezel	Front Bezel	Front Bezel	Front Bezel
Projected Capacitive touch	YES	YES	YES	YES
ECDIS Color Calibration	Optional	Optional	Optional	Optional
Mounting	Panel Mount , Vesa Mount	Panel Mount , Vesa Mount	Panel Mount , Vesa Mount	Panel Mount , Vesa Mount
Dimensions	412 x 345 x 79.7 mm 16.22 x 13.58 x 3.14 in	429 x 392 x 72.8 mm 16.889 x 15.433 x 2.866 in	595 x 385mm x 63.8 mm 23.43 x 15.16 x 2.51 in	621mm X 432.4mm X 85.5 24.44 X 17.02 X 3.66
Cutout	338 x 288 mm 13.31 x 11.34 in	408 x 359 mm 16.03 x 14.13 in	572 x 363 mm 22.51 x 14.29 in	598mm X 408mm 23.54 X 16.06
IP Rating	IP65 Front	IP65 Front	IP65 Front	IP65 Front
IEC60945, DNV, IACS E10, CE,FCC	YES	YES	YES	YES
Operating Temperature	-15 to 55°C	-15 to 55°C	-15 to 55°C	-15 to 55 c

ORDERING INFORMATION:

Commercial Display ECDIS Touch Screen Displays:	
Part Number:	Description :
CD-15T	15" 1024x768 Commercial touch screen display, 1 each VGA,DVD-D,HDMI 1.4, HDMI 2.0, HDMI 1.4, Display Port 1.2, 9-36vdc, wide dimming range, three stage ECDIS dimming Night,Dusk,Day
CD-19T	19" 1280x1024 Commercial touch screen display, 1 each VGA,DVID,HDMI 1.4,HDMI 2.1, Display Port 1.2, 9-36vdc, wide dimming range, three stage ECDIS dimming Night,Dusk,Day
CD-24T	24" 1920x1080 Commercial touch screen display, 1 each VGA,DVID,HDMI 1.4,HDMI 2.1, Display Port 1.2, 9-36vdc, wide dimming range
CD-26T	26" 1920x1200 Commercial touch screen display, 3 x VGA,1 x DVD-D,1 x HDMI 2.0, 1 x HDMI 1.4, 1 x Display Port 1.2, 9-36vdc, wide dimming range
ECDIS Option*	ECDIS Color Calibration
For ECDIS option Add -ECDIS at the end of the above part numbers (sample CD-19T-ECDIS)	

*CD Displays are ECS Compliant when paired with the MPC-E10 series computer

SRT/PHT Series

LCD Marine/Industrial Displays



10" Display
SRT/PHT-10

12" Display
SRT/PHT-12

15" Display
SRT/PHT-15

15" Wide
SRT/PHT-15W

17" Display
SRT/PHT-17

18.5" Wide
SRT/PHT-185W

19" Display
SRT/PHT-19

21" Wide
SRT/PHT-21W

24" Display
SRT/PHT-24

24" Wide
SRT/PHT-24W

27" Wide
SRT/PHT-24W

32" Wide
SRT/PHT-32W

Sunlight Readable Touchscreen (SRT) & Pilot House Touchscreen (PHT)
Displays Designed for the Industrial and Marine Industries.

- Cost Effective Glass Bridge Displays
- Up to 1500 Nits Sunlight Readable
- Wide Dimming Range
- IEC60945 Certified
- NEMA 4, IP65 Sealed Front Panel
- Front Brightness Controls

- HDMI, DVID, VGA & Composite Video Input
- Red Night Mode
- Standard PCAP Touch Screen
- HDCP Compliant
- Low Power LED Backlighting

Standard Displays



Seatronx Part Numbers:	SRT-10 &PHT-10	SRT-12 & PHT-12	SRT-15 & PHT-15	SRT-17 &PHT-17	SRT-19 &PHT-19	SRT-24 & PHT-24
FEATURES						
Diagonal (active area) Inch	10.4	12.1	15.0	17.0	19.0	24.1
Native Resolution (Pixels)	1024 x 768	1024x768	1024x 768	1280x1024	1280x 1024	1920x 1200
Colors	16.2M	16.2M	16.2M	16.7M	16.7M	16.7M
Contrast Ratio	1200	700	700	1000	1000	1000
Brightness Sunlight Readable (SRT)	1500	1500	1800	1500	1500	1000
Brightness Pilot House (PHT)	500	700	700	350	300	350
Viewing Angle (left, right)	89, 89	80,80	80, 80	85,85	89, 89	89, 89
Viewing Angle (up, down)	89, 89	80,80	60, 80	80,80	89, 89	89, 89
Backlight Lifetime (Hrs)	50000	50000	50000	50000	50000	50000
Backlight Dimming	0 - max	0 - max	0 - max	0 - max	0 - max	0 - max
Red Night Mode	YES	YES	YES	YES	YES	YES
Input terminal x1 HDCP HDMI	HDMI,DVI,VGA, Comp	HDMI,DVI,VGA, Comp	HDMI,DVI,VGA, Comp	HDMI,DVI,VGA, Comp	HDMI,DVI,VGA, Comp	HDMI,DVI,VGA, Comp
Power Source	9-34V + and -	9-34V + and -	9-34V + and -	9-34V + and -	9-34V + and -	9-34V + and -
Voltage Converter	9-34V (isolated)	9-34V (isolated)	9-34V (isolated)	9-34V (isolated)	9-34V (isolated)	9-34V (isolated)
Power Consumption (AMPS @ 24VDC)	SRT 2.5 / PHT 1.5	SRT 2.5 / PHT 1.5	SRT 2.8 / PHT 1.5	SRT 3 / PHT 1.5	SRT 3.5 / PHT 1.5	SRT 3.5 / PHT 1.8
Inlet Plug DC Power	Screw Terminal	Screw Terminal	Screw Terminal	Screw Terminal	Screw Terminal	Screw Terminal
Optional AC Power Supply	YES	YES	YES	YES	YES	YES
Dimensions Front (w x h x d mm)	262.6 x 227.6 x 58mm (10.34 x 8.960 x 2.28)	301.8 x 257.3 x 58mm (11.88 x 10.13 x2.28)	363.1 x 305.1 x 58mm (14.295 x 12.02 x 2.28)	396.9 x 342 x 58mm (15.62 x 13.46 x 2.28)	432.6 x 377.2 x 58mm (17.03 x 14.85 x 2.28)	598.6 x 382.8 x 66.8mm (23.57 x 15.07 x 2.63)
Cutout Dimensions (w x h x d mm)	244.4 x 209.4 x 61mm (9.623 x 8.224 x 2.40)	283.6 x 239.1 x 61mm (11.16 x 9.43 x 2.40)	345.1 x 287.1 x 61mm (13.58 x 11.30 x 2.40)	378.9 x 324 x 61mm (14.92 x 12.75 x 2.40)	414.6 x 359.2 x 61mm (16.32 x 14.14 x 2.40)	580.6 x 364.8 x 61mm (22.86 x 14.36 x 2.40)
Sealing Front	ip68 with potentiometer	ip68 with potentiometer	ip68 with potentiometer	ip68 with potentiometer	ip68 with potentiometer	ip68 with potentiometer
Mounting	panel mount/Vesa	panel mount/Vesa	panel mount/Vesa	panel mount/Vesa	panel mount/Vesa	panel mount/Vesa
Operating Temperature (°C)	-30 to 70	-30 to 85	-30 to 85	-30 to 85	0 to 70	0 to 50
Storage Temperature (°C)	-30 to 80	-30 to 80	-30 to 85	-30 to 85	-20 to 70	-20 to 60
Parameter Adjustment	front knob and osd at backside	front knob and osd at backside	front knob and osd at backside	front knob and osd at backside	front knob and osd at backside	front knob and osd at backside
Power On/Off	front knob and osd at backside	front knob and osd at backside	front knob and osd at backside	front knob and osd at backside	front knob and osd at backside	front knob and osd at backside
Projected Capacitive Touch	YES	YES	YES	YES	YES	YES
Optical Bonding	YES	YES	YES	YES	YES	YES
Remote Control	Optional	Optional	Optional	Optional	Optional	Optional

Standard USB Touchscreen Connection; RS-232 Touchscreen Connection Available Add -232 To Part Number (Example: SRT-19-232)
Available With External Power Dimming Control; Consult Factor For Details

Wide Screen Displays



Seatronx Part Numbers:	SRT-15W & PHT-15W	SRT-19W & PHT-19W	SRT-22W & PHT-22W	SRT-24W-1080 & PHT-24W-1080	SRT-27W-1080 & PHT-27W-1080	SRT-32W & PHT-32W
FEATURES						
Diagonal (active area) Inch	15.6	18.5	21.5	24.0	27.0	32.0
Native Resolution (Pixels)	1920x1080	1920 x 1080	1920x1080	1920 x 1080	1900 x 1080	1920x1080
Colors	16.2M	16.7M	16.7	16.7M	16.7M	16.7M
Contrast Ratio	1500	1000	5000	1000	1000	3000
Brightness Sunlight Readable (SRT)	1500	1500	1000	1000	1000	1000
Brightness Pilot House (PHT)	400	300	300	350	350	450
Viewing Angle (left, right)	89,89	89, 89	89, 89	89, 89	89, 89	89, 89
Viewing Angle (up, down)	89,89	89, 89	89, 89	89, 89	89, 89	89, 89
Backlight Lifetime (Hrs)	50000	50000	50001	50000	50000	50000
Backlight Dimming	0 - max	0 - max	0 - max	0 - max	0 - max	0 - max
Red Night Mode	YES	YES	YES	YES	YES	YES
Input terminal x1 HDCP HDMI	HDMI,DVI,VGA, Comp	HDMI,DVI,VGA, Comp	HDMI,DVI,VGA, Comp	HDMI,DVI,VGA, Comp	HDMI,DVI,VGA, Comp	HDMI,DVI,VGA, Comp
Power Source	9-34V + and -	9-34V + and -	9-34V + and -	9-34V + and -	9-34V + and -	9-34V + and -
Voltage Converter	9-34V (isolated)	9-34V (isolated)	9-34V (isolated)	9-34V (isolated)	9-34V (isolated)	9-34V (isolated)
Power Consumption (AMPS @ 24VDC)	SRT 3.2 / PHT 2	SRT 3.5 / PHT 1.5	SRT 3.5 / PHT 1.8	SRT 3.5 / PHT 1.8	SRT 3.5 / PHT 1.8	SRT 4.4 / PHT 2.4
Inlet Plug DC Power	Screw Terminal	Screw Terminal	Screw Terminal	Screw Terminal	Screw Terminal	Screw Terminal
Optional AC Power Supply	YES	YES	YES	YES	Yes	YES
Dimensions Front (w x h x d mm)	403.8 x 272.5 x 58 mm (15.89 x 10.72 x 2.28)	466.2 x 307.4 x 61mm (18.35 x 12.1 x 2.40)	538 x 345.4 x 58mm (21.18 x 13.59 x 2.28)	598.6 x 382.8 x 61mm (23.57 x 15.07 x 2.40)	660.6 x 418.0 x 61mm (26.01 x 16.46 x 2.40)	774.2 x 479.4 x 76.8mm (30.48 x 18.87 x 3.02)
Cutout Dimensions (w x h x d mm)	385.8 x 254.5 x 61 mm (15.18 x 10.01 x 2.40)	448.2 x 289.4 x 61mm (17.65 x 11.39 x 2.40)	520 x 327.4 x 61mm (20.47 x 12.88 x 2.40)	580.6 x 364.8 x 61mm (22.86 x 14.36 x 2.40)	642.6 x 400 x 61mm (25.3 x 15.75 x 2.40)	756.2 x 461.4 x 71mm (29.77 x 18.17 x 2.8)
Sealing Front	ip68 with potentiometer	ip68 with potentiometer	ip68 with potentiometer	ip68 with potentiometer	ip68 with potentiometer	ip68 with potentiometer
Mounting	panel mount/Vesa	panel mount/Vesa	panel mount/Vesa	panel mount/Vesa	panel mount/Vesa	panel mount/Vesa
Operating Temperature (°C)	-20 to 75	0 to 70	to 50	0 to 50	0 to 50	0 to 50
Storage Temperature (°C)	-20 to 80	-20 to 70	-20 to 60	-20 to 60	-20 to 60	-20 to 60
Parameter Adjustment	front knob and osd at back-side	front knob and osd at back-side	front knob and osd at back-side	front knob and osd at back-side	front knob and osd at back-side	front knob and osd at back-side
Power On/Off	front knob and osd at back-side	front knob and osd at back-side	front knob and osd at back-side	front knob and osd at back-side	front knob and osd at back-side	front knob and osd at back-side
Projected Capacitive Touch	YES	YES	YES	YES	YES	YES
Optical Bonding	YES	YES	YES	YES	YES	YES
Remote Control	Optional	Optional	Optional	Optional	Optional	Optional

SRT Series Sunlight Readable Touch Screen Displays	
Part #:	Description :
SRT-10	10" 1024x768 Sunlight readable touch screen display, 9-36vdc, 1 HDMI, 1 DVDI, 1 VGA, 1 Composite, wide dimming range
SRT-12	12" 1024x768 Sunlight readable touch screen display, 9-36vdc, 1 HDMI, 1 DVDI, 1 VGA, 1 Composite, wide dimming range
SRT-15	15" 1024x768 Sunlight readable touch screen display, 9-36vdc, 1 HDMI, 1 DVDI, 1 VGA, 1 Composite, wide dimming range
SRT-17	17" 1280x1024 Sunlight readable touch screen display, 9-36vdc, 1 HDMI, 1 DVDI, 1 VGA, 1 Composite, wide dimming range
SRT-19	19" 1280x1024 Sunlight readable touch screen display, 9-36vdc, 1 HDMI, 1 DVDI, 1 VGA, 1 Composite, wide dimming range
SRT-24	24" 1920x1200 Sunlight readable touch screen display, 9-36vdc, 1 HDMI, 1 DVDI, 1 VGA, 1 Composite, wide dimming range
SRT-32	32" 1920x1080 Sunlight readable touch screen display, 9-36vdc, 1 HDMI, 1 DVDI, 1 VGA, 1 Composite, wide dimming range
Wide Screen	
SRT-15W	15" Wide Screen 1920x1080 Sunlight readable touch screen display, 9-36vdc, 1 HDMI, 1 DVDI, 1 VGA, 1 Composite, wide dimming range
SRT-19W	18.5" Wide Screen 1920x1200 Sunlight readable touch screen display, 9-36vdc, 1 HDMI, 1 DVDI, 1 VGA, 1 Composite, wide dimming range
SRT-22W	22" Wide Screen 1920x1080 Sunlight readable touch screen display, 9-36vdc, 1 HDMI, 1 DVDI, 1 VGA, 1 Composite, wide dimming range
SRT-24W-1080	24" Wide Screen 1920x1080 Sunlight readable touch screen display, 9-36vdc, 1 HDMI, 1 DVDI, 1 VGA, 1 Composite, wide dimming range
SRT-27W	27" Wide Screen 1920x1080 Sunlight readable touch screen AG glass only display, 9-36vdc, 1 HDMI, 1 DVDI, 1 VGA, 1 Composite, wide dimming range
PHT Series Pilot House Touch Screen Displays	
Part #:	Description :
PHT-12	12" 1024x768 Pilothouse touch screen display, 9-36vdc, 1 HDMI, 1 DVDI, 1 VGA, 1 Composite, wide dimming range
PHT-15	15" 1024x768 Pilothouse touch screen display, 9-36vdc, 1 HDMI, 1 DVDI, 1 VGA, 1 Composite, wide dimming range
PHT-17	17" 1280x1024 Pilothouse touch screen display, 9-36vdc, 1 HDMI, 1 DVDI, 1 VGA, 1 Composite, wide dimming range
PHT-19	19" 1280x1024 Pilothouse touch screen display, 9-36vdc, 1 HDMI, 1 DVDI, 1 VGA, 1 Composite, wide dimming range
PHT-24	24" 1920x1200 Pilothouse touch screen display, 9-36vdc, 1 HDMI, 1 DVDI, 1 VGA, 1 Composite, wide dimming range
PHT-32	32" 1920x1080 Pilothouse touch screen display, 9-36vdc, 1 HDMI, 1 DVDI, 1 VGA, 1 Composite, wide dimming range
Wide Screen	
PHT-15W	15" Wide Screen 1920x1080 Pilothouse touch screen display, 9-36vdc, 1 HDMI, 1 DVDI, 1 VGA, 1 Composite, wide dimming range
PHT-19W	18.5" Wide Screen 1920x1200 Pilothouse touch screen display, 9-36vdc, 1 HDMI, 1 DVDI, 1 VGA, 1 Composite, wide dimming range
PHT-22W	22" 1920x1080 Pilothouse touch screen display, 9-36vdc, 1 HDMI, 1 DVDI, 1 VGA, 1 Composite, wide dimming range
PHT-24W-1080	24" Wide Screen 1920x1080 Pilothouse touch screen display, 9-36vdc, 1 HDMI, 1 DVDI, 1 VGA, 1 Composite, wide dimming range
PHT-27W	27" Wide Screen 1920x1080 Pilothouse touch screen AG glass only display, 9-36vdc, 1 HDMI, 1 DVDI, 1 VGA, 1 Composite, wide dimming range
Low Cost AC Powered PH Series Pilot House NON TOUCH Displays	
Part #:	Description :
PH-15-AC	15" 1024x768 Pilothouse display, AC 110 Power Supply Included , 1 HDMI, 1 DVDI, 1 VGA, 1 Composite, wide dimming range
PH-17-AC	17" 1280x1024 Pilothouse display, 12VDC AC 110 Power Supply Included , 1 HDMI, 1 DVDI, 1 VGA, 1 Composite, wide dimming range
PH-19-AC	19" 1280x1024 Pilothouse display, AC110 Power Supply Included , 1 HDMI, 1 DVDI, 1 VGA, 1 Composite, wide dimming range
PH-24-AC	24" 1920x1200 Pilothouse display, AC 110 Power Supply Included , 1 HDMI, 1 DVDI, 1 VGA, 1 Composite, wide dimming range
Accessories	
SRT/PHT-AC-PWR-24	110 vdc AC Power adapter , rating 24 vdc 5A 60w bare wire
PHT/SRT-CONTROL	The PHT/SRT-CONTROL is a compact digital control that allows for easy touch command control from any bridge. Turn displays on and off, brighten or dim to your preference, and select any input for up to 12 displays. Easy to install and operate and built with a small profile to fit in tight consoles.

PHT-550DG

Pedestal Mount 4K Marine Monitor

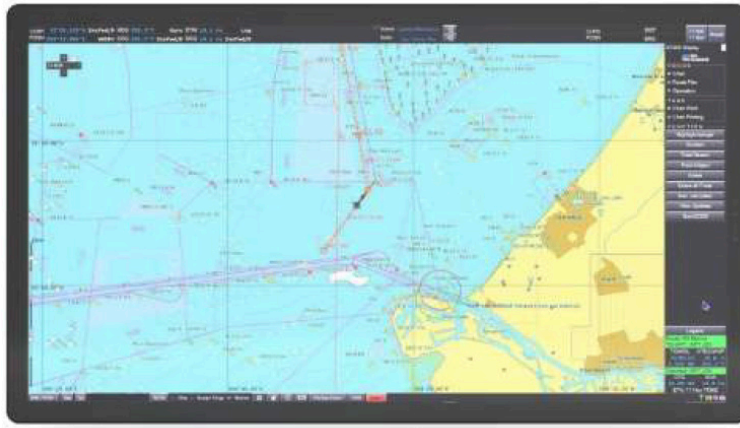

Panel	
Display [Inch]	55.0
Active area HxV [mm]	1209,6x680,4
Aspect ratio	16:9
Resolution [Pixels]	3840x2160
Viewing angle U/D/L/R [deg]	89/89/89/89
Contrast ratio	4000
Native brightness [cd/m ²]	500
High Bright [cd/m ²]	X
Mechanical	
Unit WxHxD [mm]	1289x760x67
Weight (incl. options) [kg]	55
Mounting pattern (VESA)	na

Input sources	
HDMI	V (2)
DVI-D	X
VGA	X
CVBS (BNC)	X
DP	V (2)
Power input	
12VDC (Desktop PSU 115/230VAC)	X
24VDC (Galvanic isolated)	V
Max. power native brightness [Watt]	120
Max. power high bright [Watt]	X

ORDERING INFORMATION:

Commercial Display ECDIS Touch Screen Displays:	
Part Number:	Description :
PHT-550DG	55" 4K UHD (3840×2160) display, HDMI x2, Display Port x2, DVI-D, VGA, CVBS (BNC), optional NCOM serial control, Pedestal or semi-flush desk mount, 1289x760x67 mm, 55 kg

Glass Pod Displays

Customized Glass Pods & Curved Acrylic



Get the Sleekest, Sexiest Look Guaranteed to Turn Heads with Seatronx Glass Pods.

From center consoles to super yachts, our configurable Glass Pods maximize usable helm space with a seamless glass bridge design that eliminates limited console space and restrictions. Touch Screen Glass pods enable boat builders and designers to create seamless, custom helm designs to achieve the perfect look for your custom boat or yacht.



- Watertight front ideal for pilothouse or fly bridge consoles.
- Easy Installation - Glass Pods shave hours off installation time, Equating to huge savings.
- Compatible to multiple switching for easy source selection.
- Serviceable - Displays are serviceable from rear of pod.
- Cost - Glass Pods save huge amounts of installation time from carpentry to wiring.
- Customizing - We can customize pods for your specific needs.

Below are some sample configurations. Our Glass Pods are customizable, we can customize to meet your specific needs.

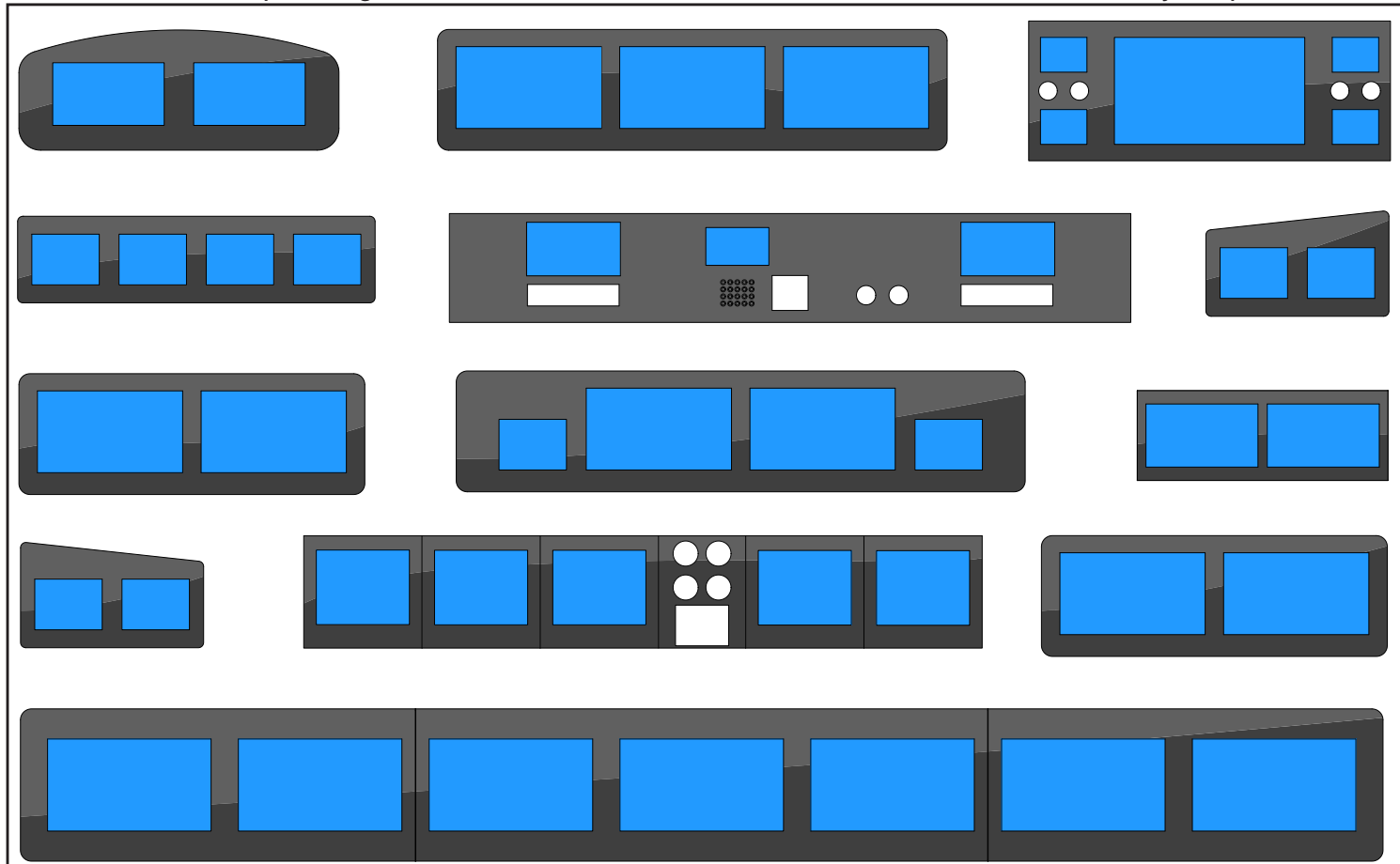

Call us to discuss your custom needs and specifications

IND Series

Rugged LED Sunlight Readable Industrial Displays

IND Series

Displays Designed for Industrial Applications.



LED- Sunlight Readable Industrial/Marine LCD Monitors These products feature the latest in LCD technology with 1,500nit LED backlights rated at 100,000 hours life. They feature optically bonded anti -reflective glass, perfect 1000:1 dimming, DVI, VGA, HDMI and Mil Spec. OSD controls.

- **IND-19T: 19" TFT LCD; 1,280 X 1,024 Resolution(SXGA) with Touchscreen**
- **IND-24W: 24" TFT LCD; Wide 1,920 X 1,080 Resolution(FHD)**
- **AC or DC Powered (10 to 38VDC; AC/DC Brick Power Supply Included)**
- **Heavy Duty Mounting Bracket Included**



SPECIFICATIONS:

IND Series	IND-19T	IND-24W
LCD Type	TFT Active Matrix LCD (16.7 Million colors)	TFT Active Matrix LCD (2.07 Million colors)
Display Size	19.0"	24.07"
Resolution	1,280 x 1,024(SXGA)	1,920 x 1,200(WUXGA)
Contrast Ratio	1,000:1	1,000:1
Brightness	LED Backlight Type- 1,500 nit(min.)	LED Backlight Type- 900 nit(min.)
Panel Surface	Anti-Glare Coating with Tempered Glass	Anti-Glare Coating with Tempered Glass
Inputs	DVI, VGA, HDMI(With PIP/POP)	DVI, VGA, HDMI(With PIP/POP)
Mounting Options	VESA / Flush/U-Bracket mounted	VESA / Flush/U-Bracket mounted
View Angle	170(H) 170 (V)	178(H) 1708(V)
Response Time	3m/sec	14m/sec
Light Source	Light Emitting Diodes	Light Emitting Diodes
Input Voltage	10 to 38VDC Power Input, AC/DC brick power supply included	10 to 38VDC Power Input, AC/DC brick power supply included
Power Consumption	34W	60W
Dimensions	17.51"(W)x14.96"(H)x2.23"(D), 445(W)x380(H)x56.8(D)mm	23.4"(W)x16.61"(H)x2.56"(D), 595(W)x422(H)x65(D)mm
Operating Range	-10C ~ 60C	-0C ~ 50C
Cases Color	Black ,Dark Gray	Black ,Dark Gray
IP Rating	Front Side:IP65, Rear Side:IP32	Front Side:IP65, Rear Side:IP32
Warranty	2 yrs	2 yrs
Dimming Range	1000:1 (dimming control to dark to full bright)	1000:1 (dimming control to dark to full bright)
Weight	13.67 LBS(6.2Kg)	22 LBS(10Kg)

ORDERING INFORMATION:

Industrial Displays	
Part Number:	Description :
IND-19T	19.0" 1000 nit TFT LCD with Touchscreen • 1,280 X 1,024 Resolution(SXGA) • 1x each HDMI, DVI, VGA • U Bracket Included • 10 to 38VDC Power Input, AC/DC Brick Power Supply Included
IND-24W	24.07" TFT LCD • 1,920 X 1,200 Resolution(WUXGA) • 10 to 38VDC Power Input, AC/DC Brick Power Supply Included

SXT EXTREME SERIES

100% SEALED IP66/IP67 WATER-PROOF
SUNLIGHT READABLE DISPLAYS



- Sunlight-readable LCD with high brightness.
- Rugged, fanless, die-cast aluminum enclosure with integrated heatsink; easy-to-clean flat surface.
- Full IP66/67 waterproof sealing with anti-corrosive rubber for 360° protection.
- 10-point PCAP touchscreen with anti-glare treatment and touch on/off control.
- Integrated OSD menu accessible directly through the touchscreen interface.
- Optical bonding with UV-resistant materials for enhanced clarity and durability.
- Shock resistant up to 20G, ideal for high-vibration marine environments.
- Certifications: CE, FCC, RoHS.

SPECIFICATIONS:

Part Number	SXT-12WHD	SXT-16W
Display	12.1" Widescreen Display	15.6" Widescreen Display
Cell Type/Glass Surface	TFT	TFT
Aspect Ratio	16:10	16:9
Active Area/ Pixel Pitch	258.048(H) ×161.28(V)mm/0.1344×0.1344mm	344.16(H) ×193.59(V)mm/0.17925×0.17925mm
Native Resolution/ Colors	1920×1200/16.7M	1920×1080/16.2M
Brightness/ Contrast	1000cd/m ³ /800:1	1500cd/m ³ /800:1
Response Time/ Viewing Angle	30ms/80/80/80/80	13/12ms/89/89/89/89
Light Source	LED backlight with 50000hours'lifetime	LED backlight with 50000 hours' lifetime
Input Signals	HDMI input (Waterproof M12 Connector)	HDMI input (Waterproof M12 Connector)
Convenient Features	Menu Adjustment, Touch on/off, Volume Control	Menu Adjustment, Touch on/off, Volume Control
Power Source	DC 9~36V (Isolated DC-DC Voltage Regulator Built-in)/Waterproof M12 Connector	DC 9~36V (Isolated DC-DC Voltage Regulator Built-in)/Waterproof M12 Connector
Power Consumption	Operation/Power Saving Below 18W	Operation/Power Saving,.: Below 35W
Touch Panel	Projected Capacitive Touch Panel with 10 Multi Touch Points,	Projected Capacitive Touch Panel with 10 Multi Touch Points
	Micro USB Port (M12 Connector)	Micro USB Port (M12 Connector)
	Plug and Play for Windows XP/7/8/10/11, Linux, Driver for Mac, Android	Plug and Play for Windows XP/7/8/10/11, Linux, Driver for Mac, Android
Key Control	Power on/off with LED, Menu, Select, Adjustment	Power on/off with LED, Menu, Select, Adjustment
Operating Temperature	-20~70°C	-20~70°C
Storage Temperature	-30~80°C	-30~80°C
Relative Humidity	10%~90%(Non-Condensing)	10%~90%(Non-Condensing)
Accessories	1×3m Power Cable, 1×3m Micro USB Cable, 1×3m HDMI Cable	1×6m Power Cable, 1×6m Micro USB Cable, 1×6m HDMI Cable

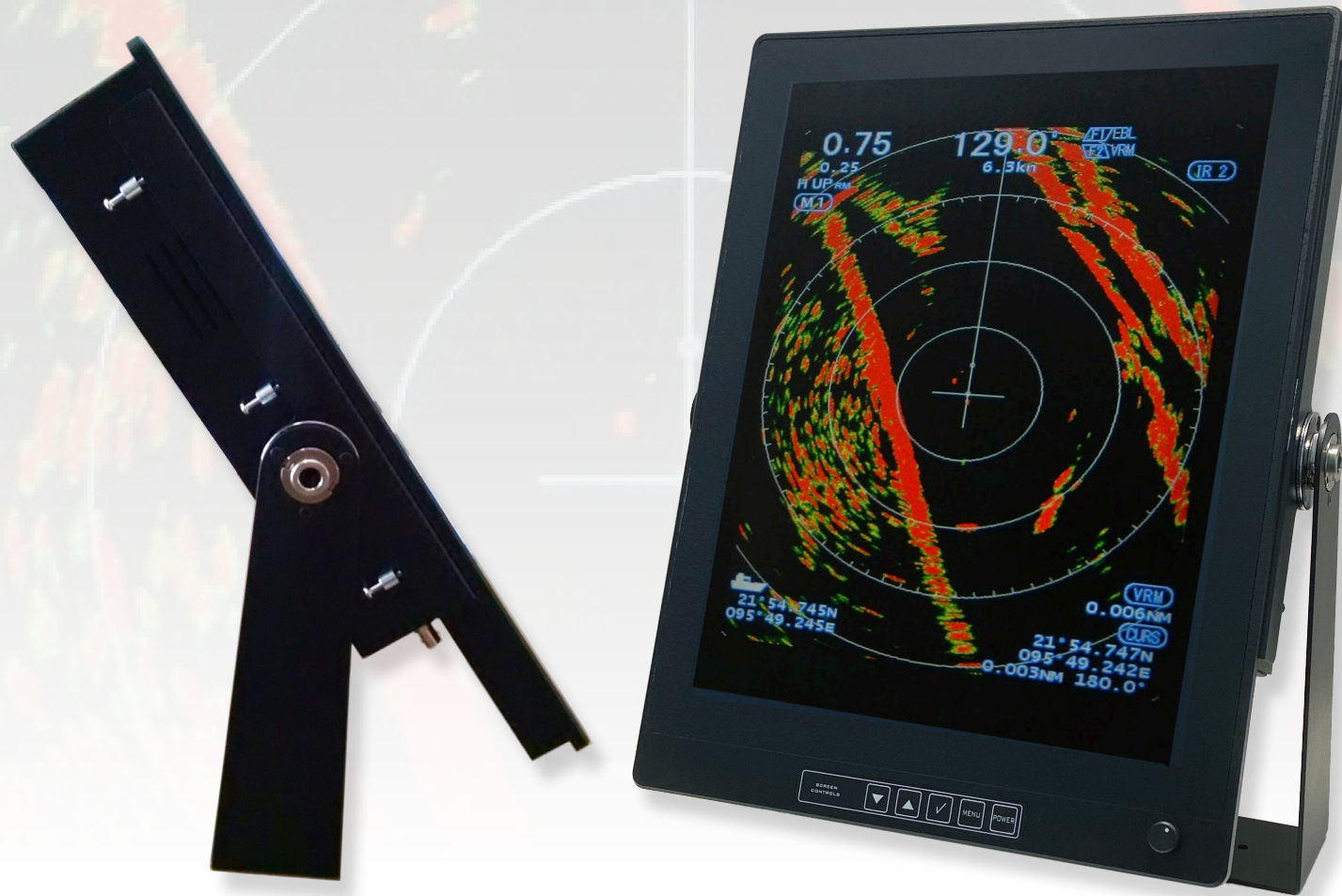

RRD & LCRD River Radar Displays

Vertical Marine Displays

The RRD (River Radar Displays) & LCRD (Low Cost River Display) displays offer portrait orientation for River Radar systems. These portrait-oriented River Radar Displays are simple to install in panel mount installations or using the various mounting options available. The LED TFT screen produces a clear and contrast-strong image both day and night, and offers wide range dimming to accommodate any lighting condition. The River Radar Displays are incredibly easy to install and use.

RRD19T

19" Vertical Marine Display

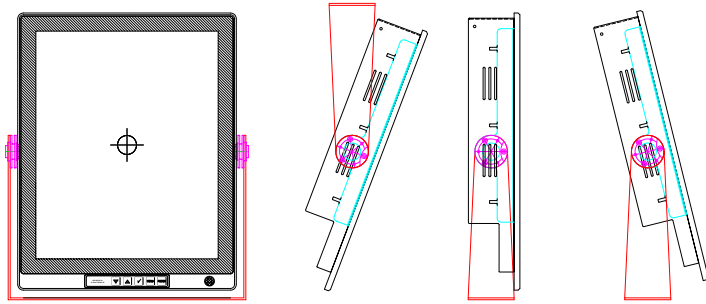

FRONT VIEW



REAR I/O PORTS VIEW

FEATURES:

- Wide Range Dimming For Clear Viewing In All Lighting Conditions
- 700+ Nits Brightness
- Red Night Mode Setting
- 1024 x 1280 Resolution
- Backlight Dimming Range 0 to Max.
- IPS Technology
- Sealed Front Panel
- Standard PCAP Touch Screen
- 9 Inputs: 2 x DVID, 2 x VGA, 1 x DP, 4 Composite
- Parameter Adjustments Via Remote Keypad
- HDCP Compliant
- Remote Control Via RS232 or IP
- 9 to 36 VDC Power
- Wide Operating Temperature

SPECIFICATIONS:

Seatronx Part Number	RRD-19T Series
Diagonal (active area) Inch	19.0
Native Resolution (Pixels)	1024 x 1280
Colors	16.7M
IPS Technology	YES
Contrast Ratio	1500:1
Brightness	700+
Viewing Angle (left, right)	89, 89
Viewing Angle (up, down)	89, 89
Backlight Lifetime (Hrs)	50000+
Backlight Dimming	0 - max
Inputs	2xDVID, 1xVGA, 1xDP,4xComp
Power Source	9-36V + and -
Voltage converter	9-36V (isolated)
Power consumption AMPS at 24vdc	3.5
Inlet plug dc power	Screw Terminal
Dimensions front (w x h x d) mm (inches)	362.10 x 437.35 x 76.20mm (14.256 x 17.219 x 3)
Cutout Dimensions (w x h x d) mm (inches)	356.22 x 430.04 x 76.20mm (14.024 x 16.931 x 3)
Sealing front	IP65
Mounting	Panel Mount or Optional U-Bracket
Operating temperature (°C)	-10 to 70
Storage temperature (°C)	-20 to 80
Parameter adjustment	Remote Keypad
Power on/off	Remote Keypad
Projected Capacitive touch	YES
Optical bonding	YES
Remote control VIA RS232 or IP	YES
Red Mode	YES

Part Number	Description
RRD-19T	19" Touchscreen, Panel Mount
RRD-19T-UB	Heavy Duty U-Bracket

LCRD19T & LCRD24T

19" & 24" Low Cost Vertical Marine Displays

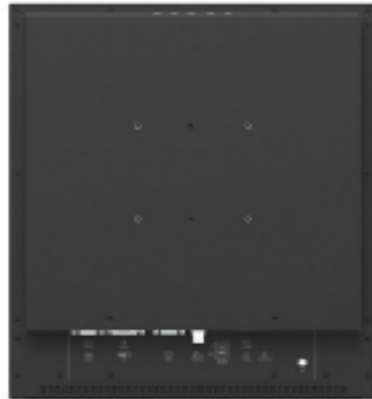

FEATURES:

- Wide Range Dimming For Clear Viewing In All Lighting Conditions
- 300 Nits Brightness (Optional 1000 Nits)
- Red Night Mode Setting
- 1024 x 1280 Resolution
- Backlight Dimming Range 0 to Max.
- IPS Technology
- Sealed Front Panel
- Standard PCAP Touch Screen
- 4 Inputs: 1 x DVID, 1 x VGA, 1 x HDMI, 1 Composite
- Parameter Adjustments Via Remote Keypad
- HDCP Compliant
- Remote Control Via RS485
- 9 to 36 VDC Power
- Wide Operating Temperature

SPECIFICATIONS:

Seatronx Part Number	LCRD-19T Series	LCRD-24T Series
Display (inches)	19.0	24.0
Active Area HxV (mm)	301.06 x 376.32	531.36x298.89
Aspect Ratio	5:4	16:9
Resolution	1280x1024	1920x1080
Viewing Angle U/D/L/R (deg)	89/89/89/89	89/89/89/89
Contrast Ration	1000	5000
Native Brightness (cd/m ²)	300	300
Native Bright (cd/m ²)	1500	1000
Dimensions WxHxD (mm)	339.2x430.9x66	345.8x595.9x66
Weight (incl. options) (kg)	6.9	9.2
Mounting Pattern (Vesa)	V (100x100 - M4)	V (100x100 - M4)
Inputs	HDMI, DVI-D, VGA, CVBS (BNC), HD-SDI (optional)	
Power Input	12VDC (Desktop PSU 115/230VAC) 9-36VDC (Galvanic isolated) (optional)	
Max Power Native Brightness (Watt)	30	40
Max Power High Brightness (Watt)	65	56

Part Number	Description
LCRD-19T	Low Cost 19" Touchscreen
LCRD-24T	Low Cost 24" Touchscreen

Rack Drawers

Rack Drawer Mount With Displays & Keyboards

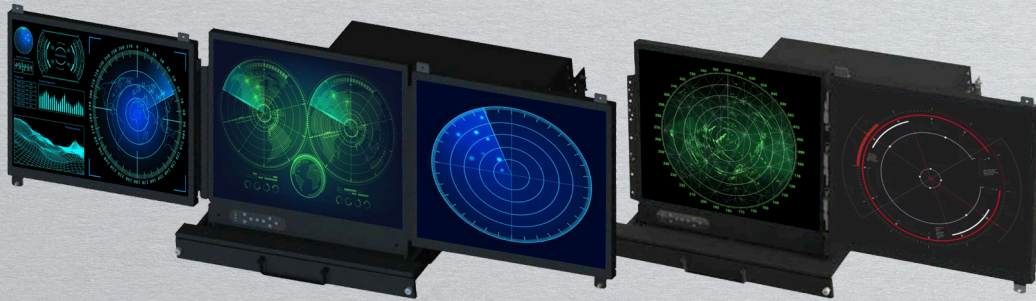

MDRM-19



IND-xx-RDKB-20



IND-xx-RD1U-24



IND-xx-RD1U-20

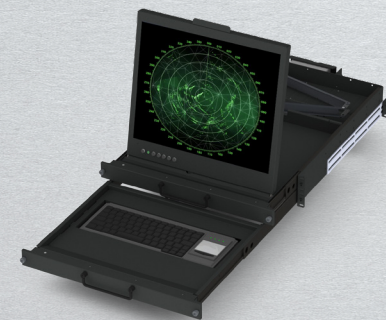

IND-xx-RDKB-KVM-20



IND-xx-RDKBMP-24

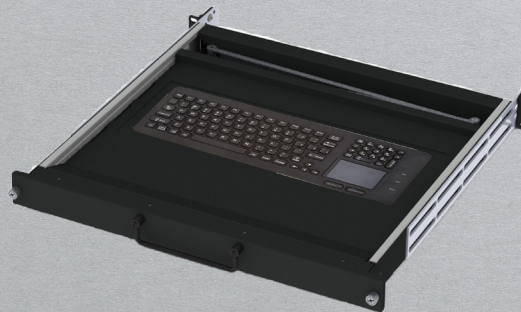

RD-KB-xx

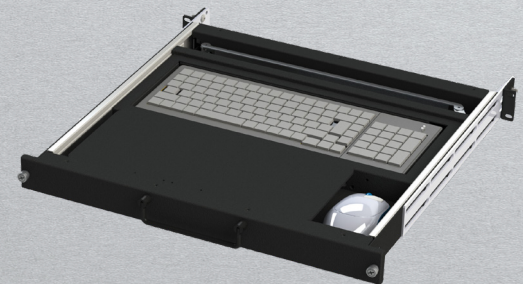

RD-KB-KVM-xx

Seatronx Part Number	Description
MDRM-19	19" 1280x1024 LCD Multi-Display Rack Mount, Dual or Triple Display Options
IND-xx-RDKB-20	20" Depth, Rack Drawer with Rugged Clamshell Design
IND-xx-RD1U-24	24" Depth, Rack Drawer with Rugged Clamshell Design
IND-xx-RD1U-20	20" Depth, 1U KVM Rack Drawer with the Keyboard and Monitor Moving Independent of Each Other
IND-xx-RDKB-KVM-20	20" Depth, KVM Rack-Drawer with Keyboard and Monitor
IND-xx-RDKBMP-24	24" Depth, KVM Rack-Drawer with Keyboard and Monitor
RD-KB-xx	17" Depth, Rack-Drawer for Keyboard Only
RD-KB-KVM-xx	KVM Rack-Drawer for Keyboard Only

Fold Down Rack Drawers

Rack Drawer With Fold Down Display



FD-MP-20-xx

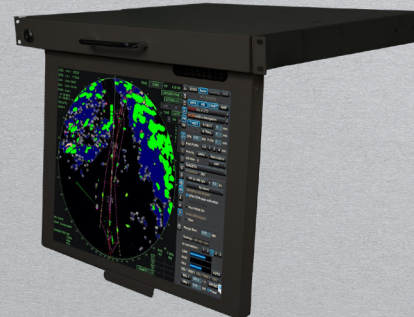

FD-MP-xx

Seatronx Part Number	Description
FD-MP-20-xx	1 U Military Drawer Mount, Multi-position Fold-Down, 19" Rack
FD-MP-xx	Fold-Down Multi-position; 1U LCD Display Drawer with 17" LCD Monitor

Sunlight Readable Rugged Tablets

RVT-7

Rugged Vehicle 7" Tablet



FEATURES

- 7" Sunlight Readable
- Dust Resistant
- Water Resistant
- Vehicle Mount Included
- Download All Your Favorite Android Apps, Maps & Software
- A Technicians Digital Multi-tool With SAEJ1939 and OBD-II Version
- Ideal For All Outdoor Applications Including, Ground Mobile

Hydros-7

Waterproof 7" Marine Tablet

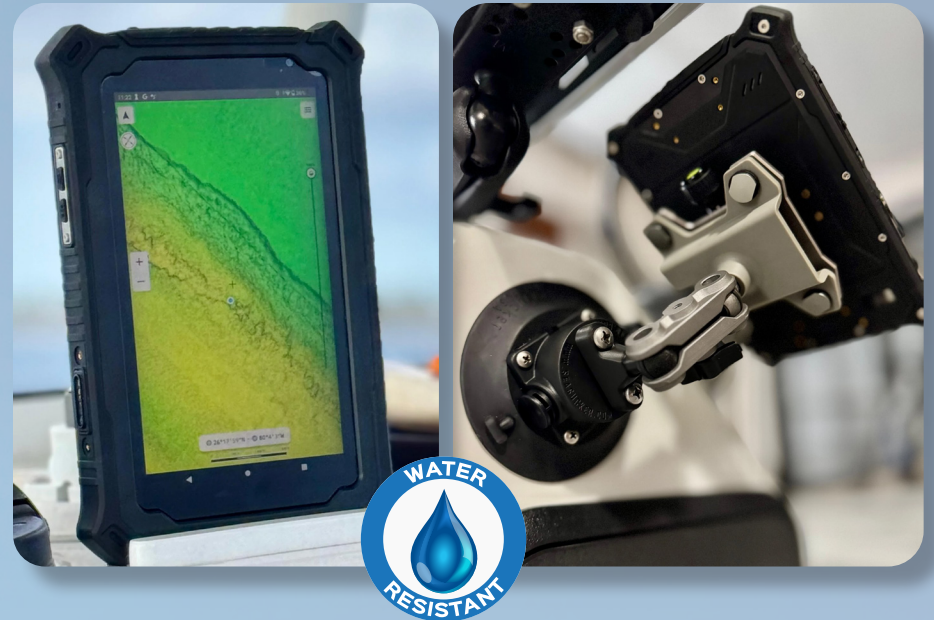

FEATURES

- 7" Sunlight Readable, Anti-glare Screen
- Waterproof and drop-proof
- Enhanced GPS Receiver
- High Endurance Battery
- Google Certified, works with all apps
- Magnetic Charger / USB C
- Marine Suction Mount
- Rugged & Portable
- 2 Year Warranty

RVT-7 Specifications

Mobile Computing Platform	Qualcomm Quad-core processor, 1.1GHz
Operating System	Android 7.1.2
RAM	2 GB
Storage	16 GB eMMC (up to 64G TF card expansion)
LCD	7" HD (1280 x800), sunlight readable 800cd/m2
Touchscreen	10 point multi touch capacitive touchscreen
Camera	front:2 MP Rear: 8 MP rear camera with LED light
Bluetooth	BT4.2 LE
WLAN	IEEE 802.11a/b/g/n; 2.4GHz/5GHz
Mobile Broadband	LTE, HSPA+, UMTS, EDGE, GPRS, GSM (Data and Voice)
GNSS	GPS/GLONASS
NFC	Read/Write Mode: ISO/IEC 14443 A&B up to 848 kbit/s, FeliCa at 212 & 424 kbit/s, MIFARE 1K, 4K NFC Forum type 1, 2, 3, 4, 5 tags, ISO/IEC 15693 All peer-to-peer modes Card Emulation Mode (from host): NFC Forum T4T (ISO/IEC 14443 A&B) at 106 kbit/s
Sound	Build-in speaker 2W x 1 85dB internal microphones x1
Interfaces	RS232 X2; GPIO Input x2; output x2; RS485 x 1 optional; RS422 x 1 optional; USB Type-A; ACC x 1; OBD II; RS232 X1; ACC x 1; J1939
Sensors	Acceleration sensors, ambient light sensor
Power	Battery: User replaceable Li-ion 5000 mAh Battery operating time: 5h(typical) DC 8-36V (ISO 7637-2 Compliant)
Buttons	Power on/off button: x1
Mounting	75mm vesa/ RAM
Dimensions	200W x 130H x 28.5D
Weight	785g

Rugged Vehicle Tablet	
Part Number:	Description :
RVT-7	Rugged Vehicle 7" Tablet

Hydros-7 Specifications

Operating System	Android
RAM	8 GB
Internal Memory	128 GB
External Memory	Micro SD card, max 256 GB
Display	10 point multi touch capacitive touchscreen
Packaging Includes	Type-C USB Cable, Magnetic Charger

Rugged Vehicle Tablet	
Part Number:	Description :
Hydros7	Waterproof 7" Marine Tablet



SCC - Seatronx Command Control

Features:

- 7" touchscreen panel with panel mount bracket included
- Processor is PoE powered, eliminating additional power cable
- POE connectivity
- Power individual and/or multiple displays on and off
- Wide dimming range control
- Clear command input selection with presets for multiple modes of operation
- Easy installation and set up.
- Fully customizable with built in menus and graphics options
- Works seamlessly with Seatronx VSRT series
- Fast and Safe operation
- Modular Video, Touchscreen, Keyboard and Mouse Switching capability



NEW Seatronx Command Control

Eliminate the need for complicated video matrix switchers and take complete control of your bridge or command center with the new Seatronx Command Control system. This system is engineered to work seamlessly with Seatronx VSRT series displays. It is a premier modular digital switching solution for any multi-display projects where easy and safe operation of systems is paramount. This new modular control is fast, reliable and customizable to all your unique requirements. Simple one touch commands allow you to easily take control of individual or multiple displays from any helm, bridge or control center.

SCC Seatronx Command Control System

Part Number:	Description :
Digital Switching Control	
SCC-PRO-3	Bridge Command Processor
SCC-7-A6	7" POE Powered Touch Panel
SCC-LIC-1	Single Touch Panel License for SCC-PRO
SCC-LIC-U	Unlimited License for SCC-PRO for multiple Touch panel controllers
*Programming fee may apply for special features-Consult Factory	
Video Matrix Options	
Select SCC-9x9VMX and then select your video input and output card options	
SCC-9x9-VMC	9 Input x 9 Output Video Matrix Chassis
SCC-VMI-HDMI	HDMI Input Card 1080p for Modular Video Matrix
SCC-VMO-HDMI	HDMI Output Card 1080p for Modular Video Matrix
SCC-VMO-HDBT	4K/30 HDBaseT Output Card up to 220' & 1080p to 330' for Modular Video Matrix
SCC-HDBT-R	4K/30 HDBaseT Receiver up to 220' & 1080p to 330'
SCC-VMI-DVI	DVI Input Card for Modular Video Matrix
SCC-VMI-VGA	VGA Input Card for Modular Video Matrix
SCC-VMO-VGA	VGA Output Card for Modular Video Matrix
SCC-VMI-SDI	SDI Input Card for Modular Video Matrix
SCC-VMO-SDI	SDI Output Card for Modular Video Matrix
SCC-VMI-Composite	Composite Input Card for Modular Video Matrix
SCC-VMO-Composite	Composite Output Card for Modular Video Matrix
SCC-VMI-Component	Component Input Card for Modular Video Matrix
SCC-VMO-Component	Component Output Card for Modular Video Matrix
SCC-VMI-Fiber	Fiber Input Card for Modular Video Matrix
SCC-VMO-Fiber	Fiber Output Card for Modular Video Matrix
KVM 8x8	
SCC-KVM-8x8	8 x 8 USB KVM Switcher
RS232 to RS485 Converter Kit	
232/485CKIT	RS232 to RS485 Serial Conversion Kit for PHY/SRT Series Monitors

SCC Push Button Controls available. Consult factory for details



SCC-PRO-3 Bridge Command Processor

PHT/SRT-CONTROL

Remote Control Unit for PHT/SRT Monitors

FEATURES

- PROTOCOL: NCOM OR SCOM
- CONNECT UPTO 12 UNITS DAISY CHAINED THROUGH RS485
- 9-36VDC POWER INPUT
- 4.3" DISPLAY
- PCAP TOUCHSCREEN
- FLUSH DESKMOUNT OR TABLETOP
- DIMENSIONS: BXHxD= 88.2X139.9X40.1MM
- SUNLIGHT READABLE (800 CD/M2)
- RESOLUTION: 480 X 272 PIXELS
- 24-BIT TRUE COLOR



PHT-SRT-CTL	
Part Number:	Description :
PHT/SRT-CONTROL	The PHT/SRT-CONTROL is a compact digital control that allows for easy touch command control from any bridge. Turn displays on and off, brighten or dim to your preference, and select any input for up to 12 displays. Easy to install and operate and built with a small profile to fit in tight consoles.
Dimensions	3.47" (88.2mm)W x 5.51" (139.9mm)H x 1.58" (40.1mm)D CUTOUT: 3.29" (83.5mm)W x 5.3" (134.5mm)H

MPPC Series

LCD Marine Panel PCs

Flat P-CAP Marine Panel PCs with 15", 19", 24" or 26" Display



- 1-24 x 768 (15"), 1280 x 1024 (19"), 1920 x 1080 (24"), 1920 x 1200 (26") resolution with projective capacitive multi-touch screen
- Edge-to-edge narrow bezel design and fanless cooling system
- Color calibrated for ECDIS compliance (Optional)
- Capacitive touch keys for quick function access and display control
- Supports ECDIS DAY, DUSK, and NIGHT mode switching
- Optional 4 x COM port (NMEA 0183 protocol) 422/485 switchable via software
- Meets the requirements of Industrial marine standards, including IEC60945 4th Edition, DNVGL-CG-0339, IACS E10
- Supports capacitive touch key lock / touchscreen lock function

SPECIFICATIONS: Commercial Panel PCs ECDIS Touch Screen Displays:						
Marine Panel PC	MPPC-15T	MPPC-19T	MPPC-24T	MPPC-27T		
Diagonal (active area) Inch	15	19	24	27		
Native Resolution (Pixels)	1024 x 768	1280 x1024	1920 x 1080	1920 x 1080		
Colors	16.7M	16.7M	16.7M	16.7M		
Contrast Ratio	1200:1	1200:1	5000:1	3000:1		
Brightness	500	350	350	300		
Viewing Angle (left, right)	89, 88	89, 89	89, 89	89, 89		
Viewing Angle (up, down)	89, 89	89, 89	89, 89	89, 89		
Backlight Dimming	-0 (3 Stage ECDIS Option)	-0 (3 Stage ECDIS Option)	-0 (3 Stage ECDIS Option)	-0 (3 Stage ECDIS Option)		
Processor	Intel i5-5200U 2.2Ghz (turbo to 2.7GHz)	Intel i5-5200U 2.2Ghz (turbo to 2.7GHz)	Intel i5-5200U 2.2Ghz (turbo to 2.7GHz)	Intel® Core™ i51335U 3.4GHz(up to 4.60 GHz)		
System Memory	16GB	16GB	16GB	16GB		
Ethernet	Dual Ethernet Gb LAN	Dual Ethernet Gb LAN	Dual Ethernet Gb LAN	Dual Ethernet Gb LAN		
Storage	256GB SSD	256GB SSD	256GB SSD	256GB SSD		
Comports	1x RS232/422/485	1x RS232/422/485	1x RS232/422/486	1x RS232/422/485		
USB	1 x USB2.0, 2 x USB3.0	1 x USB2.0, 2 x USB3.0	1 x USB2.0, 2 x USB3.1	2 x USB3.0		
HDMI out	1x HDMI	1x HDMI	1x HDMI	1x HDMI		
Operating System	Windows 11-PRO	Windows 11-PRO	Windows 11-PRO	Windows 11-PRO		
NMEA Interface	4x 0183 Port (Optional)	4x 0183 Port (Optional)	4x 0183 Port (Optional)	4x 0183 Port (Optional)		
Digital IN/OUT	8 Channel Isolated Digital Input/output (Optional)	8 Channel Isolated Digital Input/output (Optional)	9 Channel Isolated Digital Input/output (Optional)	8 Channel Isolated Digital Input/Output (Optional)		
Speaker	2x 2W Speaker	2x 2W Speaker	2x 2W Speaker	N/A		
Buzzer	75 dB~80 dB, 230 Hz, 1m	75 dB~80 dB, 230 Hz, 1m	76 dB~80 dB, 230 Hz, 1m	76 dB~80 dB, 230 Hz, 1m		
Power	9-36VDC Isolated power supply 80W (Max)	9-36VDC Isolated power supply 80W (Max)	9-36VDC Isolated power supply 80W (Max)	9-36VDC Isolated power supply 80W (Max)		
Power on/off dimming control	Front Bezel	Front Bezel	Front Bezel	Front Bezel		
Projected Capacitive touch	YES	YES	YES	YES		
ECDIS Color Calibration	Optional	Optional	Optional	Optional		
Mounting	Panel Mount , Vesa Mount	Panel Mount , Vesa Mount	Panel Mount , Vesa Mount	Panel Mount , Vesa Mount		
Dimensions	363mm X 312mm X 6.5mm (14.29" X 12.28" X 0.26")	429mm X 392mm X 72.8mm (16.889" X 15.433" X 2.866")	595mm X 385mm X 63.8mm (23.43" X 15.16" X 2.51")	665 x 432.4 x 85.5 mm 26.18 x 17.02 x 3.37 in.		
Cutout	408mm X 359mm (16.03" X 14.13")	408mm X 359mm (16.03" X 14.13")	572mm x 363mm(22.51" X 14.29")	632 x 394 mm 24.88 x 15.51 in.		
IP Rating	IP65 Front	IP65 Front	IP65 Front	IP66 Front		
IEC60945, DNV, IACS E10, CE,FCC	YES	YES	YES	CE, FCC		
Operating Temperature	-15 to 55 c	-15 to 55 c	-15 to 55 c	-15 to 55 c		

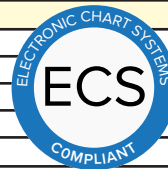
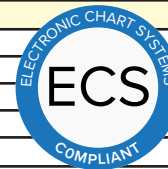
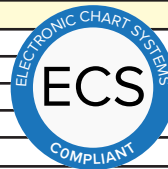
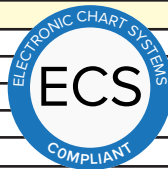

ORDERING INFORMATION: Commercial Panel PCs ECDIS Touch Screen Displays:	
Part Number:	Description :
MPPC-15T	15" 1024x768 Commercial Panel PC, I5 2.2GHz, 8GB RAM, 128GB SSD,Pre-Loaded with Win10 IoT 64 Enterprise, 9-36vdc, wide dimming with three stage ECDIS dimming Night,Dusk,Day
MPPC-19T	19" 1280x1024 Commercial Panel PC, I5 2.2GHz, 8GB RAM, 128GB SSD,Pre-Loaded with Win10 IoT 64 Enterprise, 9-36vdc, wide dimming with three stage ECDIS dimming Night,Dusk,Day
MPPC-24T	24" 1920x1080 Commercial Panel PC, I5 2.2GHz, 8GB RAM, 128GB SSD,Pre-Loaded with Win10 IoT 64 Enterprise, 9-36vdc, wide dimming with three stage ECDIS dimming Night,Dusk,Day
MPPC-27T	27" 1920x1080 Commercial Panel PC, I51335U 3.4GHz, 8GB RAM, 128 GB SSD,Pre-Loaded with Win10 IoT 64 Enterprise, 9-36vdc, wide dimming with three stage ECDIS dimming Night,Dusk,Day
ECDIS Option*	ECDIS Color Calibration

*For ECDIS option Add -ECDIS at the end of the above part numbers (sample CD-19T-ECDIS)

MPC/SEA Series

Seatronx Marine PCs



MPC-101 Compact PC



MPCRAC Rack Mount



WK430-i7-16



MPC-E10-1300



MPC-3850

SEATRONX offers the highest quality marine computers specifically designed to withstand shock and vibration, power fluctuation with wide temperature tolerance.



Part Number:	MPC-101	MPCRAC (optional MPCRAC-i7)	WK430-i7-16	MPC-E10-1300S	MPC-3850-i5-SE	MPC-3850-i7-SE
CPU	Intel Atom x6425e	Intel i5 9400 CPU (i7 optional)	i7-7600U	MPC-E10-1300-i7: Intel Core i7 2.4GHz	Core™ i5-13500TE, up to 14 Core, 24MB Cache, up to 4.5 GHz	Core™ i7-13700TE, up to 16 Cores, 30MB cache, up to 4.8 GHz
Voltage	9-48VDC (60 W power supply and 6ft power cord included)	100-240VAC	9-36VDC	9-36VDC	9-48VDC	9-48VDC
RAM	8GB DDR4 SODIMM wide temperature	16GB, DDR4 3200MHz	16GB DDR4 SO-DIMM 1866/2133 MHz	8GB, 2 x SODIMM, DDR4 2133 MHz, 4GB	8GB, 2x 260-Pin DDR4 2666 /2933MHz SODIMM. Max. up to 64GB (ECC and Non-ECC)	16 GB, DDR5 SO-DIMM wide temperature
Video	1x DVI-I	DVI / VGA / HDMI Video Out	Dual HDMI	1 x DVI 1 x Display Port 1 x HDMI Output	1x DVI-I (VGA by optional split cable); 2 x DP	1x DVI-I (VGA by optional split cable); 2 x DP
STORAGE	256 GB 2.5" SATA SSD wide temperature	2TB Hard Drive	Dual Removable HD Bay, 1T SSD	1 x M.2 256GB	512 GB 2.5" SATA/SSD	1 TB 2.5" SATA/SSD wide temperature
USB ports	3x USB 3.2 Gen2, 1x USB 2.0	2x USB 2.0 Rear; 4x USB 3.0 Rear; 2x USB 3.0 Front	2 x 2.0 and 2 x 3.0	4 x USB 3.0	8x USB 3.2 Gen 2 (10 Gbps) 1x USB 3.2 Gen 1 (5 Gbps, 1x Internal), 2x USB 2.0 (Internal)	8x USB 3.2 Gen 2 (10 Gbps) 1x USB 3.2 Gen 1 (5 Gbps, 1x Internal), 2x USB 2.0 (Internal)
Serial ports	2x RS-232/422/485	4x RS232/485 Ports	3 x RS-232, 1 x RS-485	2 x RS232/422/485	2x RS-232/422/485 ; 4x RS-232/422/485 (Internal)	2x RS-232/422/485 ; 4x RS-232/422/485 (Internal)
Ethernet	1x 2.5GbE, 1x GbE supporting (Wake-on-LAN and PXE)	1	2 x GbE	2 x RJ45	2x RJ45	2x RJ45
Expansion	2x Full-size Mini PCIe	(1) PC le 3.0 x16, (1) PC le 3.0 x16 (@ x4 maximum), (1) PC le 3.0 x1 and (1) PCI-BUS vertical	2x Full-size Mini PCIe	NA	1x M.2 (E Key, PCIe x1, USB 2.0, 2230); 1x Full-size Mini PCIe (1x shared by 1x mSATA)	1x M.2 (E Key, PCIe x1, USB 2.0, 2230); 1x Full-size Mini PCIe (1x shared by 1x mSATA)
Remote Power option	YES	Available on Request	YES	YES	YES	YES
Operating System	Windows 11 IoT Enterprise LTSC	Windows 11 IoT Enterprise LTSC	Windows 11-PRO OS	Windows 11 IoT Enterprise LTSC	Windows 11 IoT Enterprise LTSC	Windows 11 IoT Enterprise LTSC
Case Style	Rugged	Rugged Rack Mount	IP67 Waterproof	Type approved, IEC60945 DNV	Rugged	Rugged

NOTE: THE SPECIFICATIONS ABOVE ARE FOR OUR STANDARD SYSTEMS. CUSTOM SYSTEMS ARE AVAILABLE. CALL FACTORY FOR DETAILS.

Andros 8

Rugged Android Computer For Onboard Entertainment & Mobile Apps

- Built for Performance. Designed for the Water.
- Octa-Core ARM Processor + 16GB RAM
- Smooth, future-ready performance for demanding marine apps
- Android 12 OS + Google Certified
- Access the full Google Play Store for all of your favorite apps, charts, weather, fishing tools, music, and more
- Dual-Band Wi-Fi & Bluetooth
- Reliable wireless connectivity for streaming, syncing, and control
- Fully Sealed IP65/IP66/IP67 Aluminum Enclosure
- Engineered for salt, spray, and vibration in tough marine environments
- Integrated GPS with NMEA Support
- Accurate positioning for navigation and onboard system integration
- USB Touchscreen & Audio-Out Support
- Connect directly to MFDs, monitors, and onboard sound systems
- 12–36V DC Power Input for compatibility with all marine power setups



Model:	Andros 8
OS:	Android
RAM:	Solid State 16GB
Internal Memory:	128GB
External Memory:	Expandable
CPU:	ARM 8 Core RK3588
Multi Media:	8k@60fps
Bluetooth:	Bluetooth 5.2
WiFi:	WiFi 6, 2.4 & 5Ghz, Built-in High-Performance SDIO Interface Dual Antenna
Audio:	1x Audio Output
USB:	4x USB 3.0, 1 USB OTB
LAN:	1x Ethernet Port
Video Output:	1x HDMI
Power:	1x DC 9v-36v
Housing:	Aluminum Alloy, Full CNC Treated, Anodizing and Anti-Scratch Treatment
Mounting:	Aluminum Wing Tabs and VESA
Outside Dimensions:	10.75"W x 8"H
Cooling System:	Die-Casting Aluminum Chassis with Passive Cooling
Operating Temperature:	14°F to 140°F
Storage Temperature:	-4°F to 158°F
Vibration:	50-500Hz, 1.5G
Shock:	10G/Peak (11ms)
Compliance:	CE, FCC, RoHS

Comes With Everything You See Here



Trackballs & Keyboards

Type Approved and Non Type Approved



Seatronx is proud to be a distributor for NSI. NSI is the waterproof keyboard & waterproof trackball specialist delivering reliable solutions for demanding industrial, marine, medical, kiosk, food and military applications.

Illuminated trackballs make operation easy in any lighting condition. Our marine pointing devices include: waterproof trackballs, ECDIS trackballs, IEC 60945 trackballs, IP68 scroll wheel, laser trackballs and many other options and configurations.

Whatever your requirements, whatever your application, NSI wants to make sure our products will provide you the highest level of control and accuracy. Besides a large range of standard products, our dedicated team of development engineers enables NSI to deliver optimum custom products fulfilling your exact requirements.

Main trackball features

- Most extended range of trackballs
- ECDIS trackballs
- IEC 60945 trackballs
- Unique IP68 trackball solutions
- Opto-mechanical trackballs, up to IP65 sealing
- Laser-optical trackballs, IP68 sealing
- Panel mount or enclosed standard versions
- Highly robust, vandal-proof and all metal construction
- Halo backlit trackball with PWM dimming & RGB control
- Trackballs with glass panel & touch keys
- Trackballs with scroll wheel to improved ease of use
- Military grade products
- Easy customization

IEC60945 MARINE CERTIFIED TRACKBALLS

	TYPENUMBER		FORMAT	BALL	SEALING	
	<u>E38-76A31D-M017</u>	ergonomic trackball	desktop	38	IP68	
	<u>E50-76A2AD-M004</u>	ergonomic trackball	panel mount	50	IP68	
	<u>E50-76A31D-M000</u>		desktop	50	IP68	
	<u>LTSX50F8-0001-MC3</u>		panel mount, studs	50	IP68	
	<u>LTSX50F8-0BT1-MC3</u>	black carrier	panel mount, studs	50	IP68	
	<u>LTSX50N8-0001-MC3</u>		panel mount, holes	50	IP68	
	<u>LTSX50N8-0BT1-MC3</u>	black carrier	panel mount, holes	50	IP68	
	<u>MTSX38F8-0001-MC3</u>		panel mount, studs	38	IP68	
	<u>MTSX38F8-0BT1-MC3</u>	black carrier	panel mount, studs	38	IP68	
	<u>MTSX38N8-0001-MC3</u>		panel mount, holes	38	IP68	
	<u>MTSX38N8-0BT1-MC3</u>	black carrier	panel mount, holes	38	IP68	
	<u>TBE38F0-0BT1-MC3</u>	ergonomic trackball	panel mount	38	IP68	
	<u>TBE38N0-0BT1-MC3</u>	ergonomic trackball	panel mount	38	IP68	
	<u>TSX50C1-0BT1-MC3</u>	black carrier and bezel	panel mount	50	IP67	
	<u>TSX50F2-0001-MC3</u>	IP65 switches	panel mount, studs	50	IP65	
	<u>TSX50F2-0BT1-MC3</u>	IP65 switches - black carrier	panel mount, studs	50	IP65	
	<u>TSX50F8-0001-MC3</u>	IP68 switches	panel mount, studs	50	IP68	
	<u>TSX50F8-0BT1-MC3</u>	IP68 switches - black carrier	panel mount, studs	50	IP68	
	<u>TSX50N2-0001-MC3</u>	IP65 switches	panel mount, holes	50	IP65	
	<u>TSX50F2-0BT1-MC3</u>	IP65 switches - black carrier	panel mount, studs	50	IP65	
	<u>TSX50F8-0001-MC3</u>	IP68 switches	panel mount, studs	50	IP68	
	<u>TSX50F8-0BT1-MC3</u>	IP68 switches - black carrier	panel mount, studs	50	IP68	
	<u>TSX50N2-0001-MC3</u>	IP65 switches	panel mount, holes	50	IP65	
	<u>TSX50N2-0BT1-MC3</u>	IP65 switches- black carrier	panel mount, holes	50	IP65	
	<u>TSX50N8-0001-MC3</u>	IP68 switches	panel mount, holes	50	IP68	
	<u>TSX50N8-0BT1-MC3</u>	IP68 switches - black carrier	panel mount, holes	50	IP68	
		<u>TSX50S8-0001-MC3</u>		desktop	50	IP68



Full Selection available at www.seatronx.com.











INDUSTRIAL TRACKBALLS

	TYPENUMBER	INFO	FORMAT	BALL	SEALING	
	E38-76A31D	laser ball, scroll wheel	desktop	38	IP68	
	E50-76A2AD	laser ball, scroll wheel	panel mount	50	IP68	
	E50-76A31D	laser ball, scroll wheel	desktop	50	IP68	
	LTSX50F8	scroll wheel	panel mount, studs	50	IP68	
	LTSX50F8-BT1	scroll wheel - black carrier	panel mount, studs	50	IP68	
	LTSX50N8	scroll wheel	panel mount, holes	50	IP68	
	LTSX50N8-BT1	scroll wheel - black carrier	panel mount, holes	50	IP68	
	MTSX38F8	scroll wheel	panel mount, studs	38	IP68	
	MTSX38F8-BT1	scroll wheel - black carrier	panel mount, studs	38	IP68	
	MTSX38N8	scroll wheel	panel mount, holes	38	IP68	
	MTSX38N8-BT1	scroll wheel - black carrier	panel mount, holes	38	IP68	
	R38-15637F	office desktop	desktop	38	IP40	
	R55-163330	office desktop	desktop	50	IP40	
	R60-163350	office desktop	desktop	60	IP40	
	SBS25F2	steel ball	panel mount	25	IP65	
	SBS38F2	steel ball	panel mount	38	IP65	
	SBS50F2	steel ball	panel mount	50	IP54	
	TBE38F0	laser ball, scroll wheel	panel mount, studs	38	IP68	
	TBE38N0	laser ball, scroll wheel	panel mount, holes	38	IP68	
	TBS25F2	black ball	panel mount	25	IP65	
	TBS38F2	black ball	panel mount	38	IP65	
	TBS50F2	black ball	panel mount	50	IP65	
	TBS50F2-BT1	black ball - black carrier	panel mount	50	IP65	
	TBX50B1	black carrier and bezel	panel mount, studs	50	IP67	
	TCL50F1	backlit - black front	panel mount	50	IP65	
	TCS50F4	backlit - blank front	panel mount	50	IP65	
	TCX50F8	halo RGB backlit	panel mount	50	IP68	
	TSW50F5	self draining	panel mount	50	IP67	
	TSX38F8	IP68 switches	panel mount	38	IP68	
	TSX50F2	IP65 switches	panel mount	50	IP65	
	TSX50F2-BT1	IP65 switches - black carrier	panel mount	50	IP65	
	TSX50F8	IP68 switches	panel mount	50	IP68	
	TSX50F8-BT1	IP68 switches - black carrier	panel mount	50	IP68	
		TSX50N2	IP65 switches	panel mount, holes	50	IP65
	TSX50N2-BT1	IP65 switches- black carrier	panel mount, holes	50	IP65	
	TSX50N8	IP68 switches	panel mount, holes	50	IP68	
	TSX50N8-BT1	IP68 switches - black carrier	panel mount, holes	50	IP68	
	TSX50S8	IP68 switches	desktop	50	IP68	





Full Selection available at www.seatronx.com.

JOYSTICK & TOUCHPADS

	TYPENUMBER	INFO	FORMAT	SEALING
	<u>CST100F2</u>	dual function joystick	panel mount	IP55
	<u>CST100S2</u>	dual function joystick	desktop	IP55
	<u>SPS55F8</u>	stainl. steel touchpad unit	panel mount	IP68
	<u>TPD-55A326</u>	6 inch glass touchpad	desktop	IP65
	<u>TPP-55A1A6</u>	6 inch glass touchpad	panel mount	IP65
	<u>TPM-85A526</u>	6 inch glass touchpad	OEM	IP65

IEC60945 MARINE CERTIFIED KEYBOARDS	TYPENUMBER	FORMAT	BACKLIT	SEALING	COUNTRY LAYOUTS (xx)																																																			
					NA	US	CY	BE	FR	ES	FI	IT	UK	DK	S	NO	DE	KO	CN	TR																																				
					xx=	1	7	32	33	34	##	39	44	45	46	47	49	82	86	90																																				
 no pointer	<u>KSM103B00xx-W-MC</u>	panel mount / bezel	yes	IP67		US	CY						FR								IT	UK	DK	S				DE	KO	TR																										
 ergonomic trackball E50	<u>KSME103B00xx-W-M</u>	panel mount / bezel	yes	IP67		US	CY																								UK	DK	S			DE	KO	TR																		
	<u>KSME103S00xx-W-M</u>	desktop	yes	IP67		US	CY																													UK	DK	S			DE	KO	TR													
 ergonomic trackball E38	<u>KSGE92B00xx-W-MC</u>	panel mount / bezel	yes	IP67		US	CY																																	DE																
	<u>KSGE92S00xx-W-MC</u>	desktop	yes	IP67		US	CY																																		DE															
 ergonomic trackball E38	<u>KSGE103B00xx-W-M</u>	panel mount / bezel	yes	IP67		US																																		FR		DE	KO													
	<u>KSGE103S00xx-W-M</u>	desktop	yes	IP67		US																																			FR		DE	KO												
 50 mm IP68 ball	<u>KSML92F00xx-W-MC</u>	panel mount	yes	IP67		US	CY																																			DE														
	<u>KSML92S00xx-W-MC</u>	desktop	yes	IP67		US	CY																																			DE														
 50 mm ball	<u>KSML106F00xx-W-M</u>	panel mount	yes	IP65		US																																			FR		DE	KO												
	<u>KSML106B00xx-W-M</u>	panel mount / bezel	yes	IP65		US																																			FR		DE	KO												
	<u>KSML106S00xx-W-M</u>	desktop	yes	IP65		US																																				FR		DE	KO											
 50 mm IP68 ball	<u>KSMLX106F00xx-W-M</u>	panel mount	yes	IP67		US	CY																																				IT	UK	DK	S		DE	KO	TR						
	<u>KSMLX106B00xx-W-M</u>	panel mount / bezel	yes	IP67		US	CY																																					IT	UK	DK	S		DE	KO	TR					
	<u>KSMLX106S00xx-W-M</u>	desktop	yes	IP67		US	CY																																					IT	UK	DK	S		DE	KO	TR					
 rubber, 25 mm ball	<u>BKCT92F00xx-W-MC</u>	panel mount	yes	IP67		US	CY																																								FR		IT		S	NO	DE	KO	TR	
	<u>BKCT92S00xx-W-MC</u>	desktop	yes	IP67		US	CY																																									FR		IT		S	NO	DE	KO	TR
 rubber, ergonomic ball	<u>BKTE85B00xx-W-MC</u>	panel mount	yes	IP67		US	CY																																										FR	FI		DK		DE	CN	
	<u>BKTE85S00xx-W-MC</u>	desktop	yes	IP67		US	CY																																											FR	FI		DK		DE	CN
 rubber, no pointer	<u>BKB85B00xx-W-MC1</u>	panel mount	yes	IP67		US	CY																																											FR	FI		DK		DE	CN
	<u>BKB85S00xx-W-MC1</u>	desktop	yes	IP67		US	CY																																												FR	FI		DK		DE

Full Selection available at www.seatronx.com.

INDUSTRIAL KEYBOARDS					COUNTRY LAYOUTS (**)																				
					NA	US	CY	BE	FR	ES	FI	IT	UK	DK	S	NO	DE	KO	CN	TR					
					xx=	1	7	32	33	34	##	39	44	45	46	47	49	82	86	90					
INDUSTRIAL KEYBOARDS					TYPENUMBER	FORMAT	BACKLIT	SEALING	NA	US	CY	BE	FR	ES	FI	IT	UK	DK	SW	NO	DE	KO	CN	TR	
					xx=	1	7	32	33	34	358	39	44	45	46	47	49	82	86	90					
	rubber, 25 mm ball	RKCT92FxxUSB-WLED	panel mount	yes	IP67	US	CY	FR		IT		S	NO	DE	KO		TR								
		RKCT92SxxUSB-WLED	desktop	yes	IP67	US	CY	FR		IT		S	NO	DE	KO		TR								
	rubber, mousebutton	RKMB105SxxUSB	desktop	no	IP65	US	CY	FR										DE		TR					
		RKMB105SxxUSB-WLED	desktop	yes	IP65	US	CY	FR											DE		TR				
		RKMB105VxxUSB	desktop, VESA	no	IP65	US	CY	FR												DE		TR			
		RKMB105VxxUSB-WLED	desktop, VESA	yes	IP65	US	CY	FR												DE		TR			
	rubber, ergonomical trackball (E38)	RKTE85B00xx-WLED	panel mount	yes	IP67	US	CY	FR	FI		DK							DE		CN					
		RKTE85S00xx-WLED	desktop	yes	IP67	US	CY	FR	FI		DK									DE		CN			
	rubber, no pointer	RKB85B00xx-WLED	panel mount	yes	IP67	US	CY	FR	FI		DK								DE		CN				
		RKB85S00xx-WLED	desktop	yes	IP67	US	CY	FR	FI		DK										DE		CN		

Full Selection available at www.seatronx.com.

Custom Keyboards & Control Panels

Custom designs include a large choice in:

- Front layers: Add your logo, brand colors, country layout, or key arrangements
- Panel and housing materials: Select size, color and finishing
- Ball colors
- Sealing grades up to IP68 sealed
- Backlit options
- Switching technology
- Output protocols
- Cabling
- Plus, integrated pointing devices: Trackballs, touchpads, joysticks, and more



Do you need a personalized keyboard branded with your logo or with a special shape or output? Or, a pointing device that fits perfectly into your console withstanding extreme temperatures?

We have all the necessary mechanical and electrical design facilities in order to meet specific customer and certification requirements.

CALL US AT (800) 607-1460 TO DISCUSS YOUR SPECIFIC NEEDS!

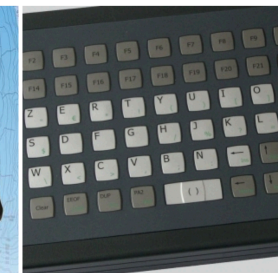

SurfVision HD Powered By SEATRONX

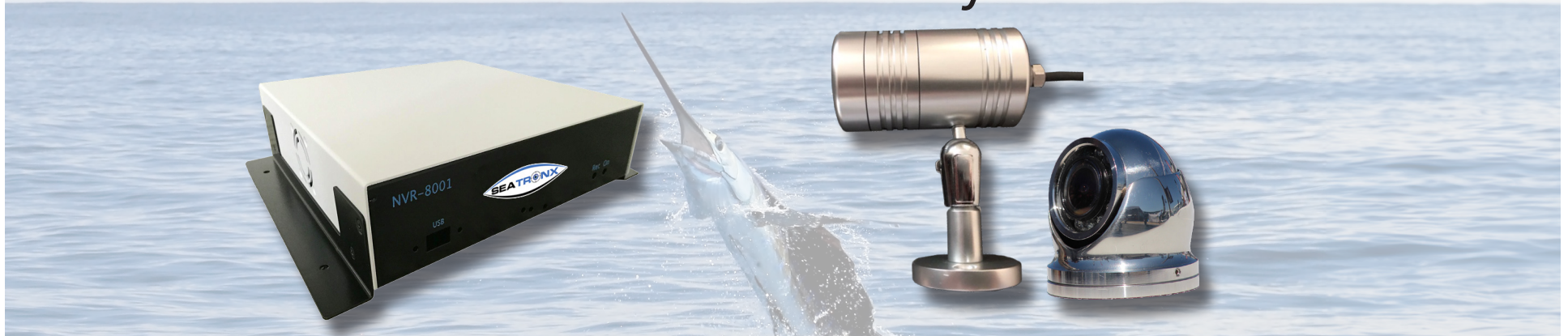

NVR-8001 Systems

Part Number:	Description :
NVR-8001-AC	AC Powered Remote Box and Marine Video Recorder with powder coated enclosure, 2TB hard disk, WiFi access, GPS overlay, Boat tracking, Integrated 8 ports POE, HDMI output, PC Windows and IOS iPhone/iPad ready.
SURF-HD-4-DC	DC Powered Remote Box and Marine Video Recorder with powder coated enclosure, 2TB hard disk, WiFi access, GPS overlay, Boat tracking, Integrated 8 ports POE, HDMI output, PC Windows and IOS iPhone/iPad ready.

Note: Units with integrated GPS can be activated to report AIS Position B messages to Marine Traffic and vessel position can be seen on Marine Traffic Web site.

Cameras

Part Number:	Description :
SV-CAM-B	Brushed Aluminum Bullet Camera, 1080p anodized custom marine IP camera up to 30 fps
ORM	Out Rigger Mount
BM	Base Plate Mount
SV-CAM-W	White Mini Dome Camera, 1080p marine IP camera up to 30 fps
SV-CAM-D-SS	Stainless Steel Mini Dome Camera, 1080p marine IP camera up to 30 fps
CAM-15M-CAB	15 Meter Cable Option

All systems are customizable to meet project requirements.



Marine & Industrial CCTV Systems

- DNV Type Approval CCTV Systems
- CCS Type Approval CCTV Systems
- IECEX & ATEX Approval Explosion Proof Cameras
- Stainless Steel Cameras & Indoor Cameras
- Underwater CCTV Cameras
- Long Range CCTV Cameras
- High-Temperature Resistant CCTV Cameras

DNV Type Approval CCTV Systems



CCS Type Approval CCTV Systems

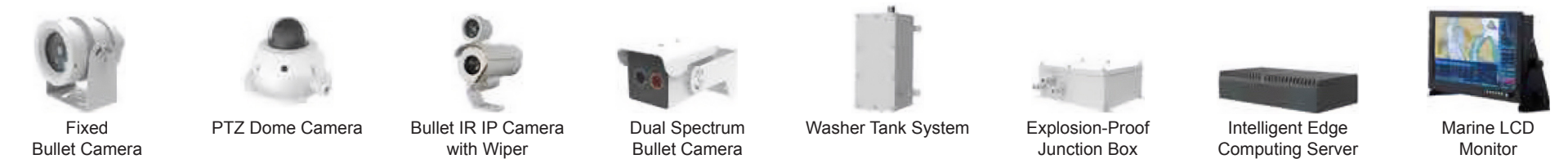

These Are Just A Sample Of Offerings Available
 See [Seatronx Rugged Industrial Camera Catalog](#) For Complete Product Offerings & Details

IECEX & ATEX Approval Explosion Proof Cameras



EX-Proof PTZ Dual Light IR Camera



EX-Proof PTZ Dome Camera



EX-Proof Fixed Dual Light Zoom Camera



EX-Proof Fixed Thermal Camera



EX-Proof IR Bullet IP Camera



EX-Proof Monitor & All-in-one PC



Explosion-Proof Junction Box



Explosion-Proof Junction Box

Stainless Steel Cameras & Indoor Cameras



Marine Fixed Dome Camera



Marine Super Wide View Camera



Marine High Speed PTZ Dome Camera



Indoor HD Color Hunter Wide Angle Fixed Turret Network Camera



Indoor IP/Network Dual Light Red & Blue Alarm Big Turret Camera



Indoor IP/Network Dual Light Red & Blue Alarm Turret Camera



Indoor IP/Network IR Mini Vandal Dome Camera



Indoor IP/Network Smart Auto-Tracking PTZ Camera

Underwater CCTV Cameras



Underwater Network Bullet HD Ultra-low Illumination Camera



Underwater HD Network PTZ Dome Camera



Underwater Network PTZ Dome Camera



Underwater HD Coaxial Mini Bullet Camera



Underwater Analog HD Pan & Tilt Camera



Borehole Camera System



Underwater Dome Camera System



Underwater Light

Long Range CCTV Cameras



Dual Light Mini PTZ Camera



T-Type Multispectral Medium-Load PTZ Camera



Heavy-Load Dual Spectrum PTZ Camera



Trispectrum Heavy-Load PTZ Camera



Multi-Spectrum Small U-Turret Camera



Dragonfly Type Turret Camera



Trispectrum Image-Stabilized Turret Camera



HD Laser PTZ Dome Camera

High-Temperature Resistant CCTV Cameras



High-Temp Resistant Air-Cooled Dome Camera



Vertical Double-Sided High-Temp Resistant Air-Water Cooled PTZ Camera



High-Intensity Light Suppression Zoom High-Temp Resistant Air-Cooled Camera



High-Temp Resistant Semiconductor Refrigeration Camera



Endoscopic Short Pinhole High-Temp Resistant Air-Water Cooled Camera



Flange-Mounted High-Temp Resistant Air-Water Cooled Camera



Cylinder-Type High-Temp Resistant Camera



Automatic Retractable Endoscopic High-Temp Resistant Thermal Imaging Camera

These Are Just A Sample Of Offerings Available
See [Seatronx Rugged Industrial Camera Catalog](#) For Complete Product Offerings & Details



Our Vision is Your Vision

The Worlds Finest
Marine Displays • Tablets • Computers & Accessories



Wherever Life's Adventures Take You...

Seatronx Is There!

Prices are subject to change without notice. Call or email for sales order or pricing confirmations.